

GE Healthcare

To Purchase, Visit

1-800-604-2155
Avobus.com



MAC[®] 5500/MAC[®] 5500 HD

Resting ECG Analysis System

Operator's Manual

Software Version 10
2046275-016 Revision A



MAC[®] 5500/MAC[®] 5500 HD
Resting ECG Analysis System
English
2010 General Electric Company.
All Rights Reserved.

Publication Information

The information in this manual only applies to MAC® 5500 and MAC® 5500 HD system software version 10. It does not apply to earlier software versions. Due to continuing product innovation, specifications in this manual are subject to change without notice.

MAC, MULTI-LINK, MUSE, MACTRODE, Ultra-Archivist, MobileLink, and 12SL are trademarks owned by GE Medical Systems *Information Technologies*, Inc., a General Electric Company going to market as GE Healthcare. All other marks are the properties of their respective owners.

This product complies with the regulatory requirements concerning medical devices from the following bodies:



The document part number and revision appear at the bottom of each page. The revision identifies the document's update level. The revision history of this document is summarized in the following table.

Revision History

Revision	Publication Date	Description
A	29 October 2010	Initial release of the document.

To access other GE Healthcare manuals, go to the Common Documentation Library (CDL), located at http://www.gehealthcare.com/user/service/biomed_tech_selfservice/services_user_doc/products/support.html and click **Cardiology**.

Contents

1 Introduction

Product Information	9
Indications for Use	9
Prescription Device Statement.....	9
Recording ECGs During Defibrillation	9
Accuracy Of the Input Signal Reproduction	10
Modulating Effects in Digital Systems	10
Installation and Connection	10
Parts and Accessories	10
Equipment Symbols.....	17
Product and Packaging Labeling	19
Equipment Identification.....	22
Regulatory and Safety Information	24
Safety Conventions	24
Safety Messages.....	24
Classification	28
Underwriters Laboratories, Inc.	28
EMI/EMC Requirements	28
Legal Notice	29
Responsibility of the Manufacturer.....	29
Responsibility of the Purchaser/Customer.....	29
Service Information	29
Service Requirements	29
Additional Assistance	29
Manual Information	30
Manual Purpose	30
Intended Audience	30
Document Conventions	30
Related Documentation.....	31
Training.....	31

2 System Overview

Hardware Description	33
Front View	33
Back View	34
Internal View	34
Back Panel.....	35
Keyboard — Standard Keys.....	36
Keyboard — Exercise Test Keys (Option).....	37
Acquisition Equipment	38
Acquisition Module	38
Leadwire Labels	39
Leadwire Adapters	40
Connecting Peripherals	40
Connecting the LAN Option.....	41

	Connecting the Modem Option	41
	Connecting the MobileLink Wireless Option	41
	Connecting External Exercise Devices	41
	Connecting the Acquisition Device	41
	Verifying Correct Operation	42
	Software Overview	42
	Test Screens	42
	Main Menu	45
	Report Layout	48
	Entering Data	50
3	Preparing the Patient	
	Preparing the Patient's Skin	54
	Electrode Placement	55
	Resting ECG Placement	55
	Exercise ECG Placement	60
4	Entering Patient Information	
	Manually Entering Patient Information	64
	Reading a Patient Card (Option)	64
	Connecting the Card Reader	65
	Reading a Patient ID Card	65
	Scanning a Bar Code (Option)	66
	Connecting the Bar Code Scanner	66
	Scanning the Bar Code	66
	Entering Orders	67
	Receiving Orders from a MUSE CV System (Option)	67
	Manually Entering Orders	69
	Selecting and Completing Orders	69
5	Recording an ECG	
	Hookup Advisor	71
	Standard ECGs	73
	Signal Averaged ECGs	75
	Master's Step ECGs	76
6	Exercise Stress Testing	
	Starting a Stress Test	77
	Pretest Phase	78
	Exercise Phase	79
	Recovery Phase	81

	Test End Phase	81
7	Editing Protocols	
	Protocol Overview	83
	Editing or Creating Protocols	85
8	Printing ECG Reports	
	Printing Another Report	89
	Printing Stored ECGs	89
	Storing Printouts	90
9	Transmitting ECGs	
	Transmitting ECGs via Modem	91
	Transmitting ECGs Locally	92
	Transmitting ECGs Wirelessly	93
	Transmitting ECGs in XML Format.....	94
10	Receiving ECGs	
	Receiving ECGs from Another MAC System.....	95
	Receiving ECGs via Modem	95
	Receiving ECGs Locally	96
	Receiving ECGs from a MUSE CV System.....	96
11	Editing ECGs	
	Editing Demographic Information	99
	Editing ECG Measurements.....	100
	Editing Interpretive Statements.....	101
12	Deleting ECGs and Orders	
	Deleting ECGs.....	103
	Deleting Orders.....	104
13	Using an SD Card	
	Supported SD Cards	107
	Preparing the SD Card.....	108

	Locking and Unlocking the SD Card.....	108
	Inserting and Ejecting the SD Card.....	108
	Formatting the SD Card.....	108
	Managing Files on the SD Card	109
	Displaying Stored ECGs.....	109
	Copying Files to the SD Card.....	109
	Restoring Files from the SD Card.....	110
	Saving Files in XML Format.....	110
	Updating Software from the SD Card.....	111
14	System Setup	
	System Setup Hierarchy.....	113
	Process Overview.....	115
	Setting Up Automatic Tasks.....	116
	Setting Up Power Up Function.....	116
	Setting Up ECG Preview.....	116
	Setting Up Resting ECG Report Printing.....	117
	Setting Up Automatic ECG Storing.....	117
	Setting Up Automatic ECG Transmission.....	118
	Setting Up Signal Averaged ECG Report Printing.....	118
	Setting Up ACI-TIPI Interpretation.....	118
	Setting Up System Basics.....	119
	Miscellaneous Setup.....	119
	Patient Questions.....	121
	Screen Colors.....	124
	Transmission.....	124
	Network Settings.....	126
	Option Activation.....	126
	Date and Time.....	128
	Language.....	128
	Power Up Options.....	129
	Order Manager Interface.....	129
	Input Method.....	130
	Setting Up ECGs	131
	ECG Acquisition.....	131
	ECG Analysis.....	133
	Patient Questions.....	134
	Writer Setup.....	135
	ECG Reports.....	135
	Analog Outputs.....	141
	CT Data Guard.....	142
	Critical Values Setup.....	143
	Setting Up Signal Averaged ECGs.....	146
	Setting Up Exercise Tests	146
	Miscellaneous Setup.....	147
	Patient Questions.....	147
	Writer Setup.....	148
	Exercise Reports.....	148
	Screen.....	153
	Inputs and Outputs.....	153

Hi-Res	155
Setting Up a Card Reader	156
Automatic Configuration.....	157
Manual Configuration.....	157
Setting Up a Bar Code Reader	158
Automatic Configuration.....	158
Manual Configuration.....	158
Setting Up Master's Step Test	159
Managing System Setup	160
Printing System Setup.....	160
Saving System Setup.....	160
Restoring System Setup.....	160

A Maintenance

Inspecting and Cleaning the MAC System	163
Inspecting the MAC System.....	163
Cleaning and Disinfecting Exterior Surfaces.....	164
Cleaning, Disinfecting, and Storing ECG Cables and Leadwires.....	165
Cleaning, Disinfecting, and Storing Handheld Devices.....	167
Paper Maintenance	170
Setting the Correct Paper Size.....	170
Loading the Paper.....	171
Battery Maintenance	172
Charging the Battery.....	172
Conditioning the Battery.....	173
Replacing the Battery.....	173
Replacing Leadwire Adapters	174

B Troubleshooting

General Troubleshooting Guidelines	177
Visual Inspection	177
Performance Problems	177
Unacceptable Noise Levels.....	177
ACI-TIPI Report Does Not Print.....	178
External Device Does Not Record BP Readings.....	178
Treadmill/Ergometer Does Not Move.....	178
System Errors	179

C Report Formats

Numeric Reports	181
Additional Reports	182
In-Test Reports	183

	Exercise Final Reports	184
	Exercise Report Codes.....	185
D	Master's Step Data	
	Master's Step Table.....	187
	ST-T Changes	190
E	Creating Bar Codes and Magnetic Cards	
	Manual Reader Configuration	191
	Automatic Reader Configuration	193

1

Introduction

This chapter provides information required for the proper use of the product and manual. Familiarize yourself with this information before using the product.

Product Information

This section provides a general overview of the product. A detailed description of the product can be found in Chapter 2, System Overview.

Indications for Use

The MAC 5500/5500 HD ECG Analysis System is intended to acquire, analyze, display, and record electrocardiographic information from adult and pediatric populations. Basic systems deliver 3, 6, 12, or 15 lead ECG's, interpretive analysis, vector loops, and can be upgraded to provide software analysis options such as high resolution signal averaging of QRS and P wave portions of the electrocardiogram. Transmission and reception of ECG data to and from a central ECG cardiovascular information system is optional.

The MAC 5500 HD is intended to be used under the direct supervision of a licensed healthcare practitioner, by trained operators in a hospital or medical professional's facility.

Prescription Device Statement

CAUTION: United States federal law restricts this device to sale by or on the order of a physician.

Recording ECGs During Defibrillation

This equipment is protected against the effects of cardiac defibrillator discharge to ensure recovery, as required by test standards. The patient signal input of the acquisition module is defibrillation-proof. Therefore, it is not necessary to remove the ECG electrodes prior to defibrillation.

When using stainless steel or silver electrodes a defibrillator discharge current may cause the electrodes to retain a residual charge causing a polarization or dc offset voltage. This electrode polarization will block acquisition of the ECG signal. To avoid this condition, use non-polarizing electrodes (which will not form a dc offset voltage when subjected to a dc current) such as silver/silver-chloride types if there is a situation where there is a likelihood that a defibrillation procedure will be necessary.

If polarizing electrodes are used, we recommend disconnecting the leadwires from the patient before delivering the shock.

Electrode defibrillation recovery is the ability of the electrode to allow the ECG trace to return after defibrillation. We recommend using non-polarizing disposable electrodes with defibrillation recovery ratings as specified in AAMI EC12 4.2.2.4. (Refer to “[Parts and Accessories](#)” on [page 10](#) for a list of approved electrodes.) AAMI EC12 requires that the polarization potential of an electrode pair does not exceed 100mV, 5 seconds after a defibrillation discharge.

Accuracy Of the Input Signal Reproduction

- Overall System Error meets AAMI EC11 3.2.7.1.
Overall System Error is between or within +/-5%.
- Frequency Response meets AAMI EC11 3.2.7.2 methods A and D.
Frequency response is between or within +/- 10% between 0.67 and 40 Hz and between +0 and -10% for 20 ms, 1.5 mV triangular input.

Modulating Effects in Digital Systems

This device uses digital sampling techniques that may produce some variation in amplitudes of Q, R, and/or S waves from one heart beat to the next, which may be particularly noticeable in pediatric recordings. If this phenomenon is observed, the clinician should be aware that the origin of amplitude variations is not entirely physiologic. For measuring voltages of Q, R, and S waves, it is advisable to use the QRS complexes with the largest deflection of the particular waves.

Installation and Connection

If the installation of this equipment, in the USA, will use 240 V rather than 120 V, the source must be a center-tapped, 240 V, single-phase circuit.

Contact GE Healthcare for information before connecting any devices to this equipment not recommended in this manual.

Parts and Accessories

To ensure patient safety, use only parts and accessories manufactured or recommended by GE Healthcare.

Parts and accessories used must meet the requirements of the applicable IEC 601 series safety standards, and/or the system configuration must meet the requirements of the IEC 60601-1-1 medical electrical systems standard.

The use of ACCESSORY equipment not complying with the equivalent safety requirements of this equipment may lead to a reduced level of safety of the resulting system. Consideration relating to the choice shall include:

- use of the accessory in the patient vicinity; and
- evidence that the safety certification of the accessories has been performed in accordance to the appropriate IEC 60601-1 and/or IEC 60601-1-1 harmonized national standard.

The following sections identify the parts and accessories approved for use with this device. Not all items have been approved for use in all countries. Please check with your local GE Healthcare representative for country availability.

Electrodes

The following non-polarizing electrodes have been approved for use with this device.

Electrodes

Part Number	Description
21714401	Suction Bulb Electrode, Thorax Electrode
42101600	Blue Suction Bulb
91920031	SilverTRACE ECG Electrodes, Soft P55MO, foam round, wet gel, 25/pouch, 200/box
2014780-001	SilverTRACE ECG Electrodes, Soft Stress PS50MO, foam round, wet gel, 30/pouch, 300/box
2014783-001	SilverTRACE ECG Electrodes, Window P50TR, clear tape round, solid gel, 30/pouch, 300/box
2014784-001	SilverTRACE ECG Electrodes, Window P50TR, clear tape round, solid gel, 5/strip, 300/box
2014785-001	SilverTRACE ECG Electrodes, Window P50TR, clear tape round, solid gel, 7/strip, 350/box
2014786-001	SilverTRACE ECG Electrodes, First Carbon P28MOC, foam rectangle, wet gel, carbon snap, 30/pouch, 300/box
2046545-001	ECG Electrode, Wet Gel P28 MOC, SilverTRACE Electrodes, 30/pack
402207-210	BabyMAC Electrodes, Resting ECG Electrodes, 10/card, 50/pack, 500/case
5608-003	GE Gray Suction Bulb
900703-205	SilverTRACE Ag/AgCl Electrodes, Adult Holter/Stress Electrode, Foam Oval, Wet Gel, 5/pkg, 150/box, 600/case
900703-230	SilverTRACE Ag/AgCl Electrodes, Adult Holter/Stress Electrode, Foam Oval, Wet Gel, 30/pouch, 300/case
9033-015	GE Suction Electrode & Gray Bulb
9623-003	Silver Mactrode Resting ECG Electrodes, 10/card, 100/pack, 1000/case
9623-003P	Silver Mactrode Plus Resting ECG Electrodes, 10/card, 100/pack, 1000/case
9623-103P	Silver Mactrode Plus Resting ECG Electrodes, 14/card, 140/pack, 1400/case

Leadwires

The following leadwires have been approved for use with this device.

Leadwires

Part Number	Description
2001925-003	CAM 14 ECG Leadwire, Universal, 40 in (102 cm)
2001925-004	CAM 14 ECG Leadwire, Universal, 51 in (130 cm)

Leadwires (cont'd.)

Part Number	Description
2001925-005	CAM 14 ECG Leadwire, Universal, 26 in (66 cm)
2001925-006	CAM 14 ECG Leadwire, Universal, 36 in (90 cm)
2016032-001	CAM 14 Leadwire Set, Dedicated Banana, AHA, 10/set, mixed lengths
2016032-002	CAM 14 Leadwire Set, Dedicated Banana, IEC, 10/set, mixed lengths
2016033-001	CAM 14 Leadwire Set, Dedicated Banana, AHA, 14/set, mixed lengths
2016033-002	CAM 14 Leadwire Set, Dedicated Banana, IEC, 14/set, mixed lengths
2020558-001	CAM 14 ECG Leadwire, Dedicated Banana, AHA, 36 in (90 cm), RA
2020558-002	CAM 14 ECG Leadwire, Dedicated Banana, AHA, 36 in (90 cm), LA
2020558-003	CAM 14 ECG Leadwire, Dedicated Banana, AHA, 40 in (102 cm), LL
2020558-004	CAM 14 ECG Leadwire, Dedicated Banana, AHA, 40 in (102 cm), RL
2020558-005	CAM 14 ECG Leadwire, Dedicated Banana, AHA, 26 in (66 cm), V1
2020558-006	CAM 14 ECG Leadwire, Dedicated Banana, AHA, 26 in (66 cm), V2
2020558-007	CAM 14 ECG Leadwire, Dedicated Banana, AHA, 26 in (66 cm), V3
2020558-008	CAM 14 ECG Leadwire, Dedicated Banana, AHA, 26 in (66 cm), V4
2020558-009	CAM 14 ECG Leadwire, Dedicated Banana, AHA, 26 in (66 cm), V5
2020558-010	CAM 14 ECG Leadwire, Dedicated Banana, AHA, 26 in (66 cm), V6
2020558-011	CAM 14 ECG Leadwire, Dedicated Banana, AHA, 26 in (66 cm), V3R
2020558-012	CAM 14 ECG Leadwire, Dedicated Banana, AHA, 26 in (66 cm), V4R
2020558-013	CAM 14 ECG Leadwire, Dedicated Banana, AHA, 26 in (66 cm), V7
2020558-014	CAM 14 ECG Leadwire, Dedicated Banana, AHA, 26 in (66 cm), E
2020558-015	CAM 14 ECG Leadwire, Dedicated Banana, AHA, 26 in (66 cm), H
2020558-016	CAM 14 ECG Leadwire, Dedicated Banana, AHA, 26 in (66 cm), I
2020558-017	CAM 14 ECG Leadwire, Dedicated Banana, AHA, 26 in (66 cm), M
2020559-001	CAM 14 ECG Leadwire, Dedicated Banana, IEC, 36 in (90 cm), R
2020559-002	CAM 14 ECG Leadwire, Dedicated Banana, IEC, 36 in (90 cm), L
2020559-003	CAM 14 ECG Leadwire, Dedicated Banana, IEC, 40 in (102 cm), F
2020559-004	CAM 14 ECG Leadwire, Dedicated Banana, IEC, 40 in (102 cm), N
2020559-005	CAM 14 ECG Leadwire, Dedicated Banana, IEC, 26 in (66 cm), C1
2020559-006	CAM 14 ECG Leadwire, Dedicated Banana, IEC, 26 in (66 cm), C2
2020559-007	CAM 14 ECG Leadwire, Dedicated Banana, IEC, 26 in (66 cm), C3
2020559-008	CAM 14 ECG Leadwire, Dedicated Banana, IEC, 26 in (66 cm), C4
2020559-009	CAM 14 ECG Leadwire, Dedicated Banana, IEC, 26 in (66 cm), C5
2020559-010	CAM 14 ECG Leadwire, Dedicated Banana, IEC, 26 in (66 cm), C6
2020559-011	CAM 14 ECG Leadwire, Dedicated Banana, IEC, 26 in (66 cm), E



Part Number	Description
2020559-012	CAM 14 ECG Leadwire, Dedicated Banana, IEC, 26 in (66 cm), H
2020559-013	CAM 14 ECG Leadwire, Dedicated Banana, IEC, 26 in (66 cm), I
2020559-014	CAM 14 ECG Leadwire, Dedicated Banana, IEC, 26 in (66 cm), M
2020559-015	CAM 14 ECG Leadwire, Dedicated Banana, IEC, 26 in (66 cm), C3R
2020559-016	CAM 14 ECG Leadwire, Dedicated Banana, IEC, 26 in (66 cm), C4R
2020559-017	CAM 14 ECG Leadwire, Dedicated Banana, IEC, 26 in (66 cm), C7
420101-001	CAM 14 ECG Leadwire Set, Universal, mixed length, 14/set
420101-002	CAM 14 ECG Leadwire Set, Universal, mixed length, 10/set

Leadwire Accessories

The following electrode accessories have been approved for use with this device.

Leadwire Accessories

Part Number	Description
2001926-001	Blank Plug Kit, CAM 14, 4/bag
401089-003	Leadwire Organizers, 4 3-L Separators, 2 4-L Separators
414763-002	Multi-Link Leadwire Separator, 3-L, 3/pack

ECG Adapters and Connectors

The following adapters and connectors have been approved for use with this device.

ECG Adapters and Connectors

Part Number	Description
406551-033	CAM 14 ECG Connector, Mactrode, V3R, AHA
406551-034	CAM 14 ECG Connector, Mactrode, V4R, AHA
406551-035	CAM 14 ECG Connector, Mactrode, V7, AHA
406554-033	CAM 14 ECG Connector, Banana, V3R, AHA
406554-034	CAM 14 ECG Connector, Banana, V4R, AHA
406554-035	CAM 14 ECG Connector, Banana, V7, AHA
900178-001	CAM 14 ECG Connector Set, Banana, 10/set, AHA
900178-002	CAM 14 ECG Connector Set, Mactrode, 10/set, AHA
900178-003	CAM 14 ECG Connector Set, Grabber, 10/set, AHA
900178-101	CAM 14 ECG Connector Set, Banana, 10/set, IEC
900178-102	CAM 14 ECG Connector Set, Mactrode, 10/set, IEC
900178-103	CAM 14 ECG Connector Set, Grabber, 10/set, IEC
900178-201	CAM 14 ECG Connector Set, Banana, 14/set, IEC

ECG Adapters and Connectors (cont'd.)

Part Number	Description
900178-202	CAM 14 ECG Connector Set, Mactrode, 14/set, IEC
900178-203	CAM 14 ECG Connector Set, Grabber, 14/set, IEC
900179-201	CAM 14 ECG Connector Set, Banana, 14/set, AHA
900179-202	CAM 14 ECG Connector Set, Mactrode, 14/set, AHA
900179-203	CAM 14 ECG Connector Set, Grabber, 14/set, AHA
9490-210	Electrode Adapter Set, 10/set
9490-214	Electrode Adapter Set, 14/set

Acquisition Module Cables

The following acquisition module cables have been approved for use with this device.

Acquisition Module Cables

Part Number	Description
2016560-001	CAM 14 Coiled Patient Cable, 50 in (1.3 m)
2016560-003	CAM 14 Coiled Patient Cable, round connector, 15 ft (4.6 m)

KISS Aspiration System Accessories

The following KISS Aspiration System accessories have been approved for use with this device.

KISS Aspiration System Accessories

Part Number	Description
21732801	Suction Electrode, KISS ES600
30344377	Swivel Attachment Arm for Kiss
30344419	Extension tube for KISS ES600 Pump, 5 ft (1.5 m)
30344427	Blind Plug for KISS
30344434	Leadwire, KISS, AHA, 50 in (127 cm), V1
30344435	Leadwire, KISS, AHA, 50 in (127 cm), V2
30344436	Leadwire, KISS, AHA, 50 in (127 cm), V3
30344437	Leadwire, KISS, AHA, 50 in (127 cm), V4
30344438	Leadwire, KISS, AHA, 50 in (127 cm), V5

KISS Aspiration System Accessories (cont'd.)

Part Number	Description
30344439	Leadwire, KISS, AHA, 50 in (127 cm), V6
30344440	Leadwire, KISS, AHA, 57 in (147 cm), LL
30344441	Leadwire, KISS, AHA, 57 in (147 cm), LA
30344442	Leadwire, KISS, AHA, 57 in (147 cm), RA
30344443	Leadwire, KISS, AHA, 57 in (147 cm), RL
38401590	KISS Leadwire Set, IEC, 10/set, mixed lengths
93204775	KISS Electrode Filter Disc, 100/bag
2022862-001	ECG Leadwire, KISS Multilead, 50 in (127 cm), I
2022862-003	ECG Leadwire, KISS Multilead, 50 in (127 cm), E
2022862-004	ECG Leadwire, KISS Multilead, 50 in (127 cm), M
2022862-005	ECG Leadwire, KISS Multilead, 50 in (127 cm), H
2022862-006	ECG Leadwire, KISS Multilead, 50 in (127 cm), A1
2022862-007	ECG Leadwire, KISS Multilead, 50 in (127 cm), A2
2022862-008	ECG Leadwire, KISS Multilead, 50 in (127 cm), A3
2022862-009	ECG Leadwire, KISS Multilead, 50 in (127 cm), A4
2024037-001	KISS ES600 Electrodes & Leadwires, Standard, 10/set, mixed lengths
2024038-001	KISS Upgrade Electrodes & Leadwires, FRANK, 4/set, 50 in (127 cm), H, E, I, M
2024039-001	KISS Upgrade Electrodes & Leadwires, NEHB, 2/set, 50 in (127 cm), Nst, Nax
2024040-001	KISS Upgrade Electrodes & Leadwires, 4/set, 50 in (127 cm), A1 - A4
30344365	Leadwire, KISS, IEC, 50 in (127 cm), C1
30344366	Leadwire, KISS, IEC, 50 in (127 cm), C2
30344367	Leadwire, KISS, IEC, 50 in (127 cm), C3
30344368	Leadwire, KISS, IEC, 50 in (127 cm), C4
30344369	Leadwire, KISS, IEC, 50 in (127 cm), C5
30344370	Leadwire, KISS, IEC, 50 in (127 cm), C6
30344371	Leadwire, KISS, IEC, 57 in (147 cm), F
30344372	Leadwire, KISS, IEC, 57 in (147 cm), L
30344373	Leadwire, KISS, IEC, 57 in (147 cm), R
30344374	Leadwire, KISS, IEC, 57 in (147 cm), N
30344375	Leadwire, KISS, IEC, 50 in (127 cm), NST
30344376	Leadwire, KISS, IEC, 50 in (127 cm), NAX
43252125	Suction Dome, KISS

To Purchase, Visit www.avobus.com 1-800-667-2955



ing thermal papers have been approved for use with this device.

Part Number	Description
9402-020	Premium Thermal-Sensitive Chart Paper, Full Page Red Grid, 8.5 in x 11 in. (216mm x 280mm) Sheet, Z-fold, Queue Hole, 300 sheets/pack, 8 packs/case, 2400 sheets/case
9402-021	Premium Thermal-Sensitive Chart Paper, Full Page Red Grid, A-4 Modified, 8.26 in x 11 in (210mm x 280mm) Sheet, Z-fold, Queue Hole, 300 sheets/pack, 8 packs/case, 2400 sheets/case
9402-024	Premium Thermal-Sensitive Chart Paper, Red Grid Blank Interpretation Area, 8.5 in x 11 in. (216mm x 280mm) Sheet, Z-fold, Queue Hole, 300 sheets/pack, 8 packs/case, 2400 sheets/case
9402-034	Archivist 100 Thermal-Sensitive Chart Paper, Full Page Red Grid, 8.5 in x 11 in. (216mm x 280mm) Sheet, Z-fold, Queue Hole, 300 sheets/pack, 8 packs/case, 2400 sheets/case
9402-035	Archivist 100 Thermal-Sensitive Chart Paper, Full Page Red Grid, A-4 Modified, 8.26 in x 11 in (210mm x 280mm) Sheet, Z-fold, Queue Hole, 300 sheets/pack, 8 packs/case, 2400 sheets/case
9402-061	Premium Thermal-Sensitive Chart Paper, Red Grid Blank Interpretation Area, 8.5 in x 11 in. (216mm x 280mm) Sheet, Z-fold, Queue Hole, 150 sheets/pack, 16 packs/case, 2400 sheets/case

Miscellaneous Accessories













The following miscellaneous accessories have been approved for use with this device.

Miscellaneous Accessories

Part Number	Description
21708318	Electrode Cream, 250ml bottle
21730701	Electrode Contact Spray, 200ml bottle
2034731-002	Electrode Gel, 250ml bottle, 4/case
2034741-002	Epicont Cream, 250ml bottle, 4/case
2046978-001	Electrode Cream, 250ml bottle, 4/case
21730702	Electrode Contact Spray, 200ml bottle, 10/box
21730705	Electrode Contact Spray, 2 L
401210-001	Signacreme® Electrode Cream, 5oz bottle, 12/case
401210-003	Signacreme® Electrode Cream, 70 oz bottle w/pump
9812-014	Signagel® Electrode Gel, 250g tube, 12/box

Equipment Symbols

The following symbols may appear on the product or its packaging.

Symbol	Description
	Type BF equipment. The acquisition module is protected from defibrillation shocks.
	Alternating Current
	Equipotential
	Charge the battery. The flashing amber LED next to this symbol indicates you must connect the system to AC power to recharge the battery.
	Waste of electrical and electronic equipment must not be disposed as unsorted municipal waste and must be collected separately. Please contact an authorized representative of the manufacturer for information concerning the decommissioning of your equipment.
	Recycle the battery.
	Consult the accompanying documentation.
	Classified with respect to electric shock, fire, mechanical, and other specified hazards only in accordance with applicable UL standards.
	To reduce the risk of electric shock, do NOT remove cover (or back). Refer servicing to qualified personnel.
	This product consists of devices that may contain mercury, which must be recycled or disposed of in accordance with local, state, or country laws. (Within this system, the backlight lamps in the monitor display contain mercury.)
	Manufacturer name and address.
	Authorized European representative.
	PCT. GOST marking symbolizing conformity with applicable Russian Gosstandart technical and safety standards.

Symbol	Description
Rx Only	USA Only: For use only on or by order of a physician.
CE	CE Mark — Symbolizes conformity with applicable EU (European Union) directives.





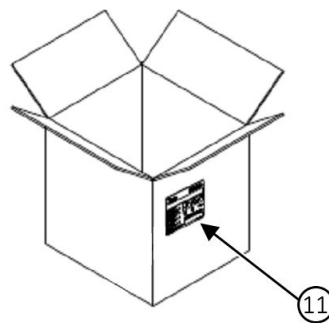
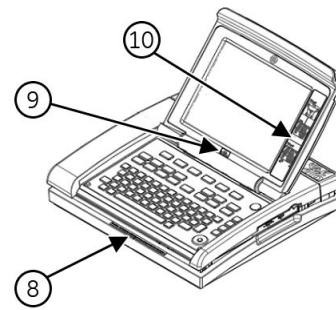
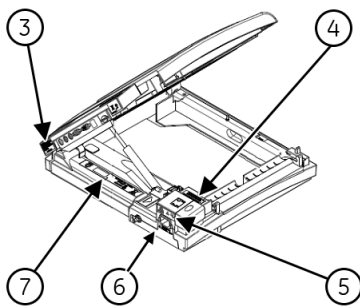
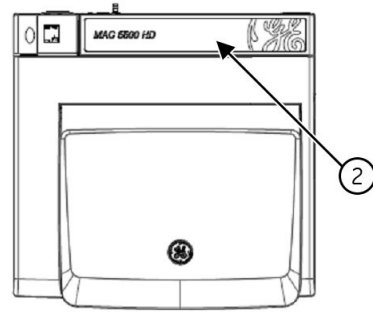
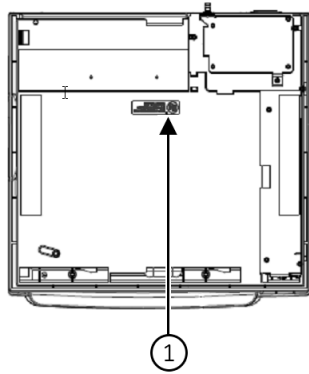

To purchase, visit Avobus.com 1-800-674-2055

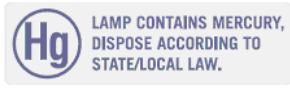

1 identifies the product labels and their locations on the product and

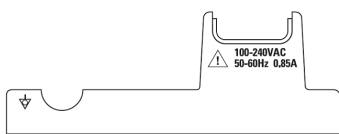
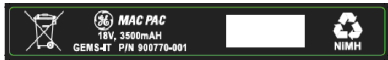

Refer to the previous illustrations for the locations of the labels identified in the following table.

No.	Label	Description
1		Located on the bottom of the device, this label indicates the device contains mercury and must be disposed of in accordance with state and local laws.
2		Located on the cover of the device, this label identifies the product's model number.
3		Located on the back of the device, this label contains the Disposal and GOST labels. Refer to “Equipment Symbols” on page 17 for detailed descriptions of the symbols.
4		Located inside the writer compartment, this label uniquely identifies this unit. Refer to “Product Label” on page 22 for detailed information.
5		Located on the back of the device, this label provides regulatory and cautionary information. Refer to “Equipment Symbols” on page 17 for detailed descriptions of the symbols.
6		Located on the back of the device, this label identifies the device's electrical ratings.
7		Located inside the battery compartment, this label provides information about the specifications and disposal of the battery. Refer to “Equipment Symbols” on page 17 for detailed descriptions of the symbols.
8		Located on the front of the device, this label indicates that, in the USA, federal law restricts sale of the device to or on the order of a physician.
9		Located below the display, this label indicates the device uses the Marquette™ 12SL™ ECG Analysis Program to analyze and interpret ECG readings.

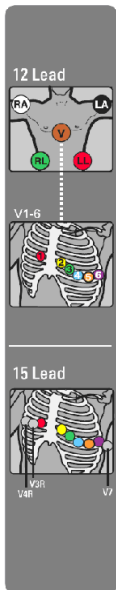
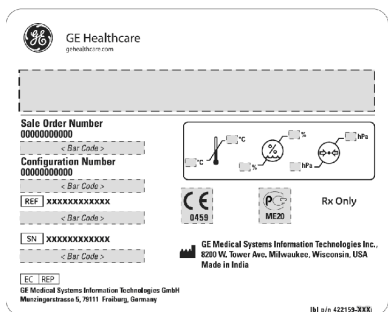
No.	Label	Description
10		<p>Located to the right of the display, this label instructs the user on where to place leads.</p>
11		<p>Located on the package, the shipping label contains the following information:</p> <ul style="list-style-type: none"> • Product description • Sales order number • Configuration number • Model number • Serial number • Storage conditions • Regulatory compliance • Country of Origin • EC Representative information

Equipment Identification

Every GE Healthcare device has a product label that identifies the product name, part number, manufacturing information, and unique serial number. This information is required when contacting GE Healthcare for support.

Product Label

The product label is laid out in the following format. Depending on the product, the label may vary slightly in format, but it contains the same information.

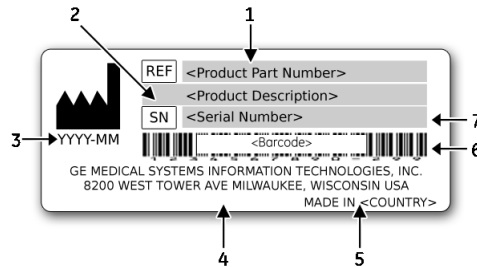

Product Label Format

Item	Description
1	Product part number
2	Product description
3	Date of manufacture in YYYY-MM format
4	Manufacturer name and address
5	Country of origin
6	Product bar code
7	Unit serial number (See “Serial Number Format” on page 22 for more information.)

Serial Number Format

Each device has a serial number that uniquely identifies the device and provides important information about the device. The serial number format is shown in the following illustration:

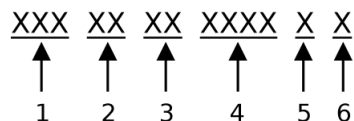

Serial Number Format

Item	Name	Description
1	Product Code	Three-letter code that uniquely identifies the product line. Refer to “Product Codes” on page 23 for more information.
2	Year Manufactured	Two-digit code identifying the year the device was manufactured. Values range from 00 to 99. For example: 00 = 2000, 04 = 2004, 05 = 2005 (and so on).
3	Fiscal Week Manufactured	Two-digit code identifying the week the device was manufactured. Values range from 01 to 52. GE Healthcare's fiscal weeks correspond to the calendar week. For example, 01 = first week in January.
4	Product Sequence	Four-digit number identifying the order in which this device was manufactured. Values range from 000 to 9999.
5	Manufacturing Site	One-letter code identifying the site where the device was manufactured. For example, F = Milwaukee, N = Freiburg, P = Bangalore
6	Miscellaneous Characteristic	For example, P = unit is a prototype, R = unit was refurbished, U = unit was upgraded to meet the specifications of another product code.

Product Codes

The product code identifies specific system platforms. You need the product code before servicing or requesting support for your device.

You can identify the product code using the serial number listed on the product label located in one of the following places:

- On the product label attached to the base the system.
- On the product label provided with the application CD.
- In the application:
 - On IT systems:
Launch the system application and click **Help > About** to view the serial number. For information on launching the application, refer to the product's service or operator's manual.
 - On MAC systems:
On the **Service Only Setup** window, select **System Setup**, press **Shift+F2**, and enter the service password to view the serial number. Contact GE Healthcare support if you do not know the service password.

Regulatory and Safety Information

This section provides information about the safe use and regulatory compliance of this device. Familiarize yourself with this information and read and understand all instructions before attempting to use this device. The system software is considered medical software. As such, it was designed and manufactured to the appropriate medical regulations and controls. Any exceptions are noted in the Compliance Information - Exceptions section.

NOTE:

Disregarding the safety information provided is considered abnormal use of this device and could result in injury, loss of data, and void any existing product warranties.

Safety Conventions

A **Hazard** is a source of potential injury to a person, property, or the product.

This manual uses the terms DANGER, WARNING, and CAUTION to point out hazards and to designate a degree or level of seriousness. Familiarize yourself with the following definitions and their significance.

Definitions of Safety Conventions

Safety Convention	Definition
DANGER	Indicates an imminent hazard, which, if not avoided, will result in death or serious injury.
WARNING	Indicates a potential hazard or unsafe practice, which, if not avoided, could result in death or serious injury.
CAUTION	Indicates a potential hazard or unsafe practice, which, if not avoided, could result in minor personal injury or product/property damage.

Safety Messages

The following messages apply to the product as a whole. Specific messages may also appear elsewhere in the manual.

WARNING:

ACCIDENTAL SPILLS — If liquids enter a device, take the device out of service and have it checked by a service technician before it is used again.

To avoid electric shock or device malfunction, liquids must not be allowed to enter the device.

WARNING:

BATTERY OPERATION — If the integrity of the protective earth conductor is in doubt, operate the unit from its battery.

WARNING:

CABLES — To avoid possible strangulation, route all cables away from the patient's throat.



ins plug must be connected to an appropriate power supply.

WARNING:

DEFIBRILLATOR PRECAUTIONS — **Do not** come into contact with patients during defibrillation. Otherwise, serious injury or death could result.

Patient signal inputs labeled with the CF and BF symbols with paddles are protected against damage resulting from defibrillation voltages.

To ensure proper defibrillation protection, use only the recommended cables and leadwires.

Proper placement of defibrillator paddles in relation to the electrodes is required to ensure successful defibrillation.

WARNING:

ELECTRODES — Polarizing electrods (stainless steel or silver constructed) may cause the electrodes to retain a residual charge after defibrillation. A residual charge will block acquisition of the ECG signal.

Whenever patient defibrillation is a possibility, use non-polarizing electrodes (silver or silver chloride construction) for ECG monitoring.

WARNING:

MAGNETIC AND ELECTRICAL INTERFERENCE — Magnetic and electrical fields are capable of interfering with the proper performance of the device.

For this reason, make sure that all external devices operated in the vicinity of the device comply with the relevant EMC requirements. X-ray equipment or MRI devices are possible sources of interference as they may emit higher levels of electromagnetic radiation.

WARNING:

EXPLOSION HAZARD — Do NOT use in the presence of flammable anesthetics vapors or liquids.

WARNING:

INTERPRETATION HAZARD — Computerized interpretation is only significant when used in conjunction with clinical findings.

A qualified physician must overread all computer-generated tracings.

WARNING:

OPERATOR — Medical technical equipment such as this system must be used only by qualified and trained personnel.

WARNING:

SHOCK HAZARD — Improper use of this device presents a shock hazard. Strictly observe the following guidelines. Failure to do so may endanger the lives of the patient, user, and bystanders.

When disconnecting the device from the power line, remove the plug from the wall outlet before disconnecting the cable from the device; otherwise, there is a risk of coming into contact with line voltage by inadvertently introducing metal parts in the sockets of the power cord.

Devices may be connected to other devices or to parts of systems only after making certain that there is no danger to the patient, operators, or environment as a result. Standards IEC 60601-1-1/EN60601-1-1 must be complied with in all cases.

WARNING:

SITE REQUIREMENTS — Improper placement of the device and/or accessories may result in a hazard to the patient, operator, or bystanders.

Do not route cables in a way that they may present a stumbling hazard.

For safety reasons, all connectors for patient cables and leadwires are designed to prevent inadvertent disconnection, should someone pull on them.

For devices installed above the patient, adequate precautions must be taken to prevent them from dropping on the patient.

WARNING:

TREADMILLS — Avoid rapid changes in treadmill speed and/or grade during a stress test.

CAUTION:

PROPER LEADWIRE CONNECTION — Improper connection will cause inaccuracies in the ECG.

Trace each individual leadwire from its acquisition module label to the colored connector and then to the proper electrode to ensure that it is matched to the correct label location.

CAUTION:

ACCESSORIES (SUPPLIES) — Parts and accessories used must meet the requirements of the applicable IEC 60601 series safety standards and essential performance standards, and/or the system configuration systems must meet the requirements of the IEC 60601-1-1 medical electrical systems standards.

To ensure patient safety, use only parts and accessories manufactured or recommended by GE Healthcare.

CAUTION:

ACCESSORIES (EQUIPMENT) — The use of accessory equipment that does not comply with the equivalent safety requirements of this equipment may lead to a reduced level of safety of the resulting system.

Consideration relating to the choice of equipment shall include:

- Use of the accessory in the patient vicinity, and
- Evidence that the safety certification of the accessory has been performed in accordance with the appropriate IEC 60601-1 and/or IEC 60601-1-1 harmonized national standard.

CAUTION:

BATTERY POWER — If a device equipped with an optional battery pack will not be used or connected to the power line for a period of over six months, remove the battery.

CAUTION:

BEFORE INSTALLATION — Compatibility is critical to safe and effective use of this device. Please contact your local sales or service representative prior to installation to verify equipment compatibility.

CAUTION:

DISPOSABLES — Disposable devices are intended for single use only. They should not be reused as performance may degrade or contamination could occur.

CAUTION:

DISPOSAL — At the end of its service life, the product described in this manual, as well as its accessories, must be disposed of in compliance with local, state, or federal guidelines regulating the disposal of such products.

If you have questions concerning the disposal of the product, please contact GE Healthcare or its representative.

CAUTION:

EQUIPMENT DAMAGE — Devices intended for emergency application must not be exposed to low temperatures during storage and transport to avoid moisture condensation at the application site.

Wait until all moisture has vaporized before using the device.

CAUTION:

ELECTRIC SHOCK — To reduce the risk of electric shock, do not remove cover or back.
Refer servicing to qualified personnel.

CAUTION:

OPERATOR — Medical technical equipment such as this electrocardiograph system must only be used by persons who have received adequate training in the use of such equipment and who are capable of applying it properly.

CAUTION:

POWER REQUIREMENTS — Before connecting the device to the power line, check that the voltage and frequency ratings of the power line are the same as those indicated on the unit's label. If this is not the case, do not connect the system to the power line until you adjust the unit to match the power source.

In the USA, if the installation of this equipment will use 240V instead of 120V, the source must be center-tapped, 240V single-phase circuit.

This equipment is suitable for connection to public mains as defined in CISPR 11.

CAUTION:

SERVICEABLE PARTS — This equipment contains no user serviceable parts.
Refer servicing to qualified service personnel.

CAUTION:

SUPERVISED USE — This equipment is intended for use under the direct supervision of a licensed health care practitioner.

To purchase, visit Avobus.com 1-800-674-2055



is classified as follows, in accordance with IEC 60601-1:

Category	Classification
Type of protection against electric shock	Class I internally powered equipment.
Degree of protection against electric shock	Type BF defibrillation-proof applied part.
Degree of protection against harmful ingress of water	Ordinary equipment (enclosed equipment without protection against ingress of water).
Degree of safety of application in the presence of a flammable anesthetic mixture with air or with oxygen or nitrous oxide	Equipment not suitable for use in the presence of a flammable anesthetic mixture with air or with oxygen or nitrous oxide.
Method(s) of sterilization or disinfection recommended by the manufacturer	Not applicable.
Mode of operation	Continuous operation.

Underwriters Laboratories, Inc.



Medical Equipment

With respect to electric shock, fire, and mechanical hazards only in accordance with applicable UL standards.

EMI/EMC Requirements

The device or system is labeled under the original equipment manufacturers label (for example, USA FCC 47CFR15, CE EU EMC 2004/108/EC), and deemed sufficient by GE Healthcare to be in compliance with EN/IEC 60601-1-2 when used according to the device or system's intended use. GE Healthcare-supplied hardware meets the applicable country requirements.

Classification	Description
Class A	The device or system is suitable for use in all establishments other than domestic and those directly connected to the public low-voltage power supply network that supplies buildings used for domestic purposes. Mains power should be a typical commercial or hospital environment.

NOTE:

Compliance provides reasonable protection against radio-frequency interference. However, there is no guarantee that interference will not occur in a particular installation. You can tell whether this device or system is causing interference by turning it off. If the interference stops, it was probably caused by the device or system.

For more information regarding the installation of this product in compliance with its electromagnetic compatibility, refer to the service manual.

Legal Notice

Our equipment contains several fields that can be filled in before performing an ECG. Some of these fields must be filled in before performing an exam; some are optional and therefore left to the user to assess whether they are needed to perform the exam. A field **Race** is one of these optional fields. Race has been acknowledged by the medical profession as useful to analyze some pathologies. You should be aware that, in some jurisdictions, the processing of data revealing an individual's racial origin is subject to legal requirements, such as obtaining the patient's prior consent. If you elect to collect this type of data, it is your responsibility to ensure that you comply with all applicable legal requirements.

Responsibility of the Manufacturer

GE Healthcare is responsible for the effects of safety, reliability, and performance on GE-supplied hardware only if the following conditions are met:

- Assembly operations, extensions, readjustments, modifications, or repairs are carried out by persons authorized by GE Healthcare.
- The electrical installation of the relevant room complies with the requirements of the appropriate local, state, and other government regulations.
- The equipment is used in accordance with the instructions for use.

Responsibility of the Purchaser/Customer

The customer is responsible for providing appropriate desks, chairs, electrical wall outlets, network connections, analog phone lines, and for locating any of the system components described in this manual in compliance with all local, state, and national codes.

Service Information

This section provides information pertaining to the maintenance and servicing of the device. Familiarize yourself with this information before requesting service from GE Healthcare or its authorized representatives.

Service Requirements

Failure on the part of the responsible individual, hospital, or institution using this equipment to implement a satisfactory maintenance schedule may cause undue equipment failure and possible safety hazards.

Regular maintenance, irrespective of usage, is essential to ensure that the components of this system are always functional when required.

Additional Assistance

GE Healthcare maintains a trained staff of application and technical experts to answer questions and respond to issues and problems that may arise during the installation, maintenance, and use of this product.

Contact your local GE Healthcare representative to request additional assistance.

Manual Information

This section provides information for the correct use of this manual.

Manual Purpose

This manual provides information necessary for the configuration and safe operation of this equipment in accordance with its function and intended use. It is not intended as a replacement for, but a supplement to, thorough product training. Keep it with the equipment at all times. Additional manuals may be ordered by contacting GE Healthcare.

Refer to the service manual for technical information related to the maintenance and repair of the equipment.

Intended Audience

This manual is intended to be used by the person(s) responsible for the configuration and operation of the equipment. It is expected that the user of this manual will complete thorough product training as well as read and understand all instructions in this manual before attempting to use the product.

Request training from GE Healthcare, if needed.

Document Conventions

This manual uses the following conventions.

Typographical Conventions

Convention	Description
Bold Text	Indicates keys on the keyboard, text to enter, or hardware items such as buttons or switches on the equipment.
<i>Italicized-Bold Text</i>	Indicates software terms that identify menu items, buttons or options in various windows.
CTRL+ESC	Indicates a keyboard operation. A plus (+) sign between the names of two keys indicates that while holding the first key, you should press and release the second key. For example, Press CTRL+ESC means to press and hold the CTRL key and then press and release the ESC key.
<space>	Indicates that you must press the spacebar. When instructions are given for typing a precise text string with one or more spaces, the point where you must press the spacebar is indicated as: <space> . This ensures that the correct number of spaces are inserted in the correct positions within the literal text string. The purpose of the < > brackets is to distinguish the command from the literal text within the string.

	Indicates that you must press the Enter or Return key on the keyboard. Do not type Enter .
>	<p>The greater than symbol, or right angle bracket, is a concise method to indicate a sequence of menu selections.</p> <p>For example, the statement "From the main menu, select System > Setup > Options to open the Option Activation window" replaces the following:</p> <ol style="list-style-type: none"> 1. From the main menu, select System to open the System menu. 2. From the System menu, select Setup to open the Setup menu. 3. From the Setup menu, select Options to open the Option Activation window.

Illustrations

All illustrations in the manual are provided as examples only. Depending on system configuration, screens that appear in the manual may differ from the screens as they appear on your system.

All patient names and data are fictitious. Any similarity to actual persons is coincidental.

Notes

Notes provide application tips or additional information that, while useful, are not essential to the correct operation of the product. They are called out from the body text through a flag word and indentation, as follows:

NOTE:

The tip or additional information appears indented below the **NOTE** flag word.

Related Documentation

The following documents are referenced in this manual and provide additional information that may be helpful in the installation, configuration, maintenance, and use of this product.

Part Number	Title
2036070-006	<i>Marquette™ 12SL™ ECG Analysis Program Physician's Guide</i>
2046275-017	<i>MAC™ 5500/MAC™ 5500 HD Resting ECG Analysis System Field Service Manual</i>
2020299-021	<i>MobileLink™ Wireless Communications Installation Manual</i>
2025521-001	<i>KISS™ Multilead Operator's Manual</i>
2020299-025	<i>LAN Option for MAC™ Resting ECG Systems Installation and Troubleshooting Guide</i>

Training

This manual is intended as a supplement to, not a substitute for, thorough product training. If you have not received training on the use of the device, you should request training assistance from GE Healthcare.

Introduction

To see available training, go to the GE Healthcare training website (<http://www.gehealthcare.com/usen/education/index.html>) and select *Diagnostic Cardiology* under the *Technical Service Education* section.

For more self-paced course offerings, tools, and reference guides you may find useful, please visit the GE Healthcare Education Store at www.gehealthcare.com/educationstore.

2

System Overview

This chapter describes the device's hardware components, software screen components, report layout, and basic navigation and data entry. Familiarize yourself with this information before using the device.

Hardware Description

This section identifies the key components of the MAC system hardware. Familiarize yourself with these components, their location, and their use before attempting to use the equipment.

Front View

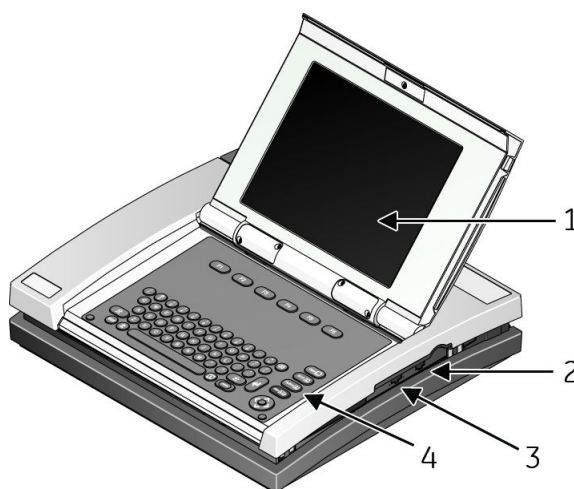

	Name	Description
1	Display Screen	View the waveform and text data.
2	Modem Port	Connect to a telephone line.

		<p>1-800-654-2155 Avobus.com</p>
	LAN Port	<p>Connect to a LAN cable. LEDs provide information about connection status.</p> <ul style="list-style-type: none"> The green LED indicates a good Ethernet link. The amber LED flashes to indicate network traffic.
4	Keyboard	Controls the system and enters data.

Back View

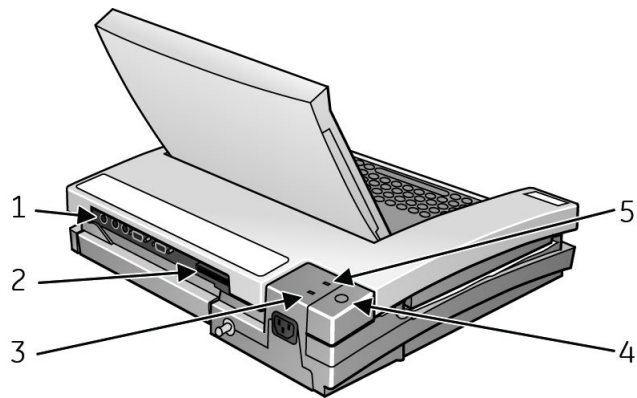

	Name	Description
1	Back panel connectors	Connect to peripherals.
2	Secure data card slot	Insert a secured data (SD) card for external storage.
3	Green AC Power	Indicates the system is connected to AC power.
4	Internal access button	Opens the system to change paper or battery.
5	Amber battery light	Indicates the battery is charging.

Internal View

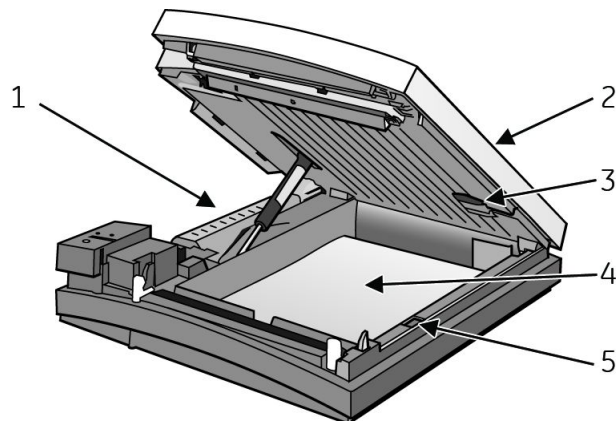

	Name	Description
1	Battery	Supplies power when unit is not connected to AC power. Recharge the battery when the battery icon flashes on-screen.
2	Writer door	Provides access to the writer, paper tray, and battery.
3	Acquisition module connector	Connects the unit to an acquisition module.
4	Paper tray	Contains the paper used to print ECGs.
5	Paper size selector	Adjusts the paper tray for STD (US Letter) or A4 paper sizes.

Back Panel

WARNING:

CURRENT LEAKAGE — Keep current leakage within acceptable limits when connecting auxiliary equipment to this device.

Total system current leakage must not exceed 100 microamperes.

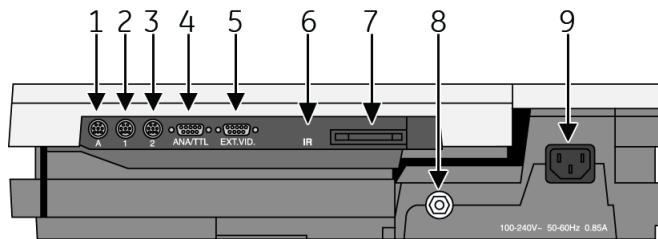

	Name	Description
1	A	Connects to an optional card reader, bar code reader, or PS/2 keyboard for entering patient information.
2	1	Connects to a GE KISS pump. When using the exercise option, connects to a T2000 treadmill or external blood pressure device. NOTE: Ergoline bicycle ergometers must be connected to both this port and the ANA/TTL port.
3	2	Connects to a local transmission cable, serial line, modem, or client bridge (wireless option).
4	ANA/TTL	Connects to a device requiring analog data or a TTL trigger. When using the exercise option, connects to an analog treadmill, ergometer cable, or TTL trigger. NOTE: Ergoline bicycle ergometers must be connected to both this port and port 1.
5	EXT.VID.	Connects to an external video display.

	Name	Description
6	IR	Exchanges ECG data with a MAC system or MUSE CV system via infrared transmission. NOTE: Depending on the age of your system, infrared transmission may not be supported.
7	Card slot	Houses a system card for external data storage or to update software.
8	Ground lug	Connects to non-grounded peripheral devices to ensure equipotential.
9	Main AC Power	Connects the system to an AC power supply via power cable.

Keyboard – Standard Keys

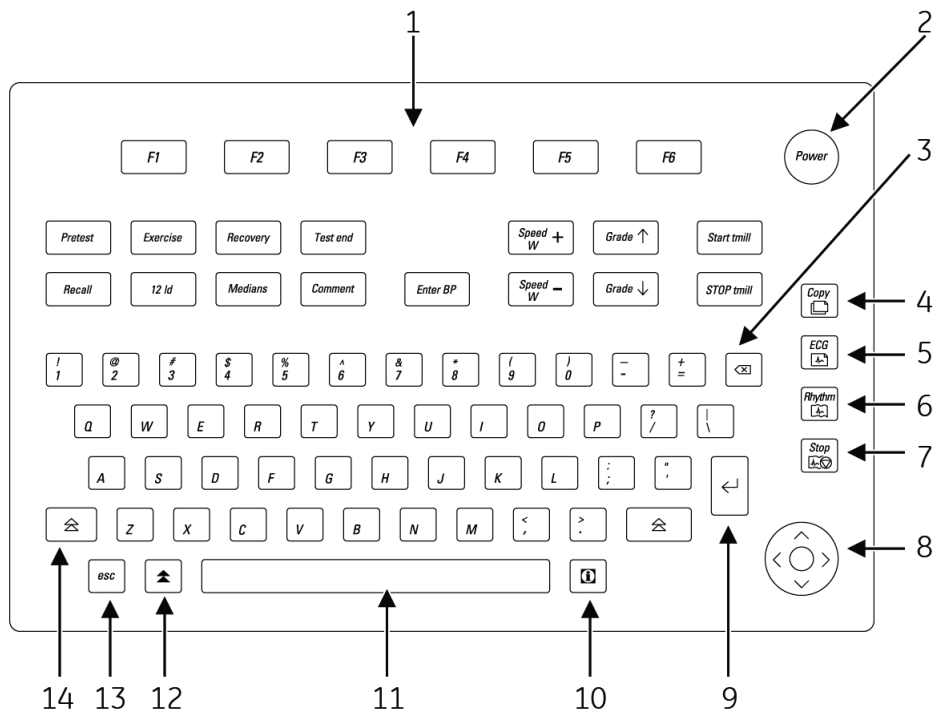

	Name	Description
1	Function keys	Selects screen menu functions.
2	Power button	Powers the system on and off.
3	Delete key	Erases typed characters.
4	Copy key	Prints an additional (copy) ECG report.
5	ECG key	Acquires a 12SL resting ECG, including measurements and interpretation.

To Purchase, Visit

1-800-601-2055 Avobus.com

	Rhythm key	Prints continuous ECG data, which cannot be stored or transmitted.
7	Stop key	Stops the writer from printing.
8	Arrow pad	Moves the cursor left, right, up, or down. Pressing the center button selects the highlighted menu or screen item.
9	Return key	Enters information into the system.
10	Information key	Provides additional user information.
11	Spacebar	Adds a space between typed characters or highlights screen items.
12	Option key	Used to create special characters on non-English keyboards.
13	Esc key	Returns to the previous menu.
14	Shift key	Creates capital letters. Press shift + p to type P .

Keyboard – Exercise Test Keys (Option)

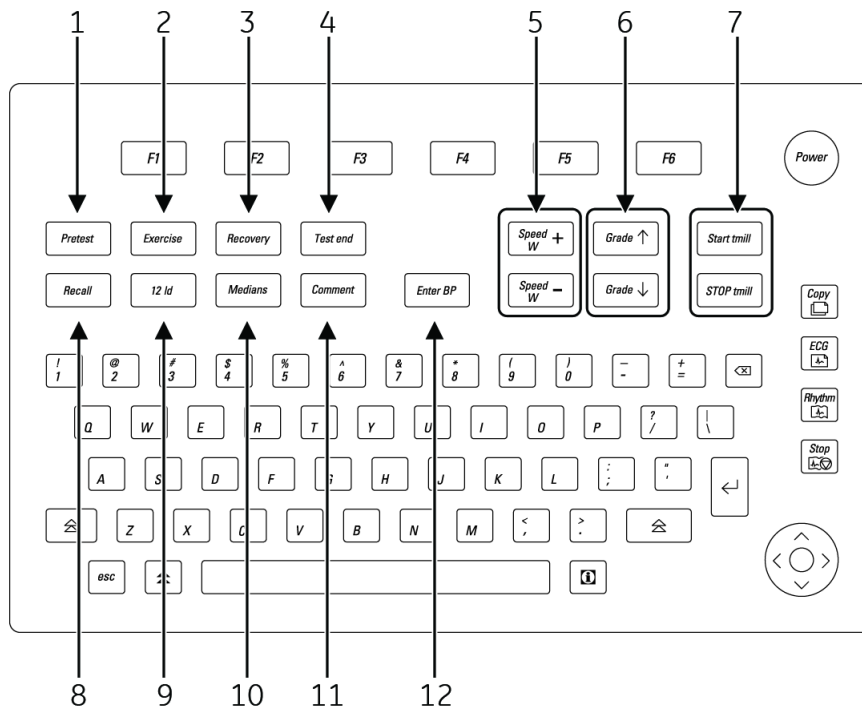

	Name	Description
1	Pretest	Advances to the next stage within the current pretest phase.
2	Exercise	Advances the exercise test to the exercise phase or to the next stage within the current exercise phase.

	Name	Description
3	Recovery	Advances the exercise test to the recovery phase or to the next stage within the current recovery phase.
4	Test end	Ends the test and starts the test end phase.
5	Speed W	Adjusts the belt speed on treadmills or load on ergometers. Press Speed W – to decrease the speed or load. Press Speed W + to increase the speed or load.
6	Grade	Adjusts the grade of the treadmill. Press Grade ↑ to increase the grade. press Grade ↓ to decrease the grade.
7	Start/STOP tmill	Starts or stops the treadmill during the test. Press Start tmill to manually start the treadmill. Press STOP tmill to manually stop the treadmill. NOTE: In the event of an emergency, press and hold the STOP tmill key to stop the treadmill quickly.
8	Recall	Prints a 10-second delayed recall report.
9	12 ld	Prints a 12-lead report with 10 seconds of acquired data.
10	Medians	Prints a medians report.
11	Comment	Allows you to enter comments about the test. Comments are printed on many of the final reports.
12	Enter BP	Allows you to enter blood pressure readings or to trigger a reading from an external device.

Acquisition Equipment

This section provides an overview of the external equipment connected to the MAC system for the acquisition of ECG data. Familiarize yourself with these components before attempting to acquire ECG data.

Acquisition Module

WARNING:

BURN PROTECTION — Use of acquisition modules other than the CAM-14 or CAM HD acquisition modules could result in high-frequency burns.

To ensure defibrillation protection and protection against serious injury, use only the CAM-14 or CAM HD acquisition modules with this equipment.

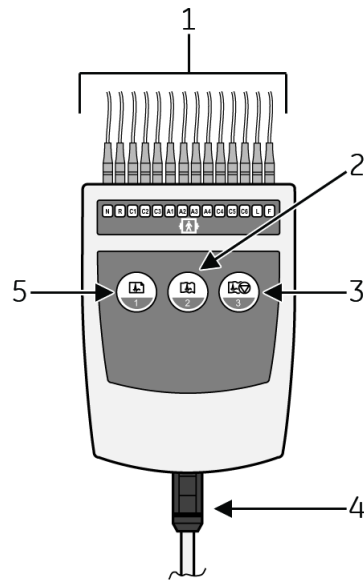

	Name	Description
1	Leadwires	Attaches to the patient electrodes. The acquisition module uses either 10 or 14 leadwires.
2	Rhythm button	Initiates the printing of a rhythm strip.
3	Stop writer button	Cancels the current print job.
4	Acquisition module cable	Connects the acquisition module to the MAC system.
5	ECG Button	Initiates the recording of an ECG.

NOTE:

If you enable the Preview before analysis function, press (5) to view the data. Then, either press (5) again to analyze the data or press (3) to discard the data.

Leadwire Labels

One of the following set of labels may appear on the acquisition device.

CAUTION:

PROPER LEADWIRE CONNECTION — Improper connection causes inaccuracies in the ECG.

Trace each individual leadwire from its acquisition module label to the color-coded connector and proper electrode to ensure that it is matched to the correct label location.

For purchase, visit

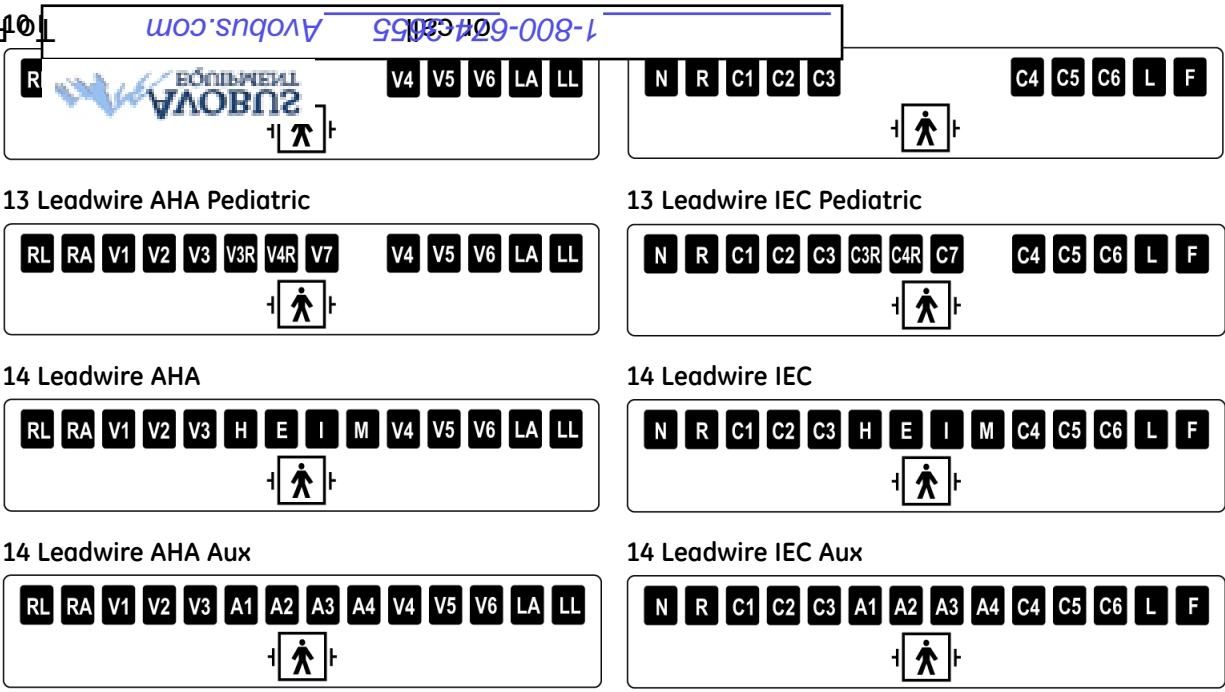

Leadwire Adapters

MULTI-LINK leadwires require one of the following adapters to connect to electrodes.

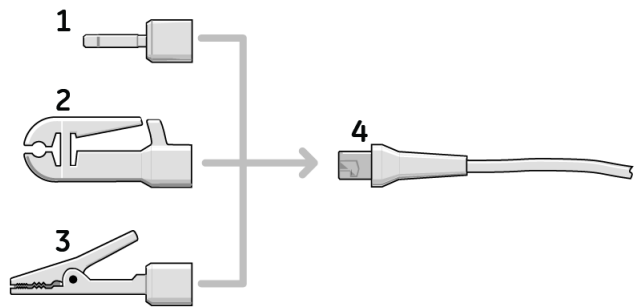

1	4 mm pin
2	Grabber
3	MACTRODE clip
4	Leadwire end

Connecting Peripherals

You should connect any of the following peripheral devices to the MAC system before powering it on:

Connecting the LAN Option

See the *LAN Option for MAC™ Resting ECG Systems Installation and Troubleshooting Guide* for information about connecting the LAN option.

Connecting the Modem Option

See the Field Service Manual for information about mounting and connecting the modem option.

Connecting the MobileLink Wireless Option

See the *MobileLink Installation and Troubleshooting Guide* for information about mounting, configuring, and connecting the wireless option.

Connecting External Exercise Devices

The following table identifies the optional exercise devices that can be connected to the MAC system and the ports through which they connect.

Port	Devices
Port 1	<ul style="list-style-type: none"> Series T2000 treadmills, SunTech Tango blood pressure device, Colin STBP-780 blood pressure device, or Ergoline 900/900L integrated blood pressure device. <p>NOTE: Before using external devices the system must be properly set up (see Chapter 14, "System Setup") and exercise protocols must be properly defined (see Chapter 7, "Editing Protocols").</p>
ANA/TTL Port	<ul style="list-style-type: none"> The Ergoline 800 ergometer. The Ergoline 900 ergometer <p>NOTE: Other bicycle ergometers and treadmill models with an analog port can be connected to the analog output of the MAC 5500. A TTL QRS trigger signal for external devices can be connected to the ANA/TTL port.</p>

Connecting the Acquisition Device

Use the following procedure to connect the acquisition device to the MAC system.

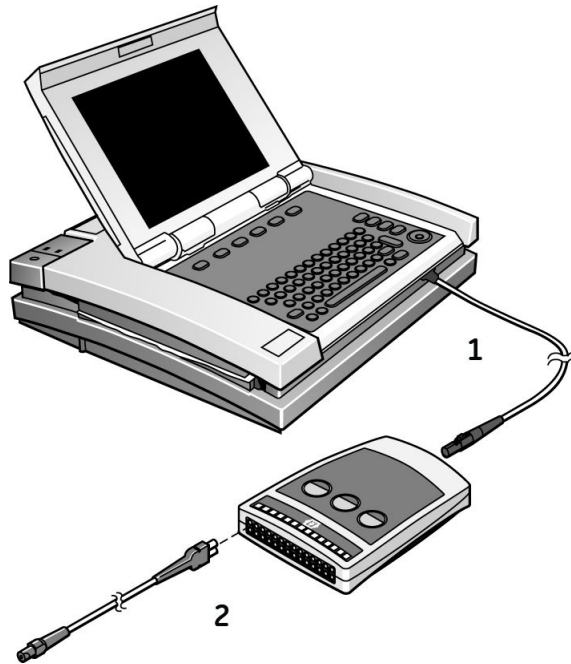

1. Connect one end of the acquisition module cable to the MAC system and the other end to the acquisition module.
 2. Connect the leadwires to the acquisition module.
- Refer to “Acquisition Equipment” on page 38 for more information.

Verifying Correct Operation

To verify the correct operation of the MAC system, press the power button to turn on the system.

- If the system starts up without displaying error messages, the system is operational.
- If the system displays error messages, turn the system power off, then on again. If error messages persist, contact GE Healthcare Service.

Software Overview

This section provides an overview of the system software. It describes the basic screen layout, main menu functions, and basic data entry and navigation techniques. Familiarize yourself with these features before attempting to use the MAC system.

Test Screens

The test screen differs depending on which test is selected, although all test screens share some common components.

Resting ECG Screen

The following illustration is the standard test screen.

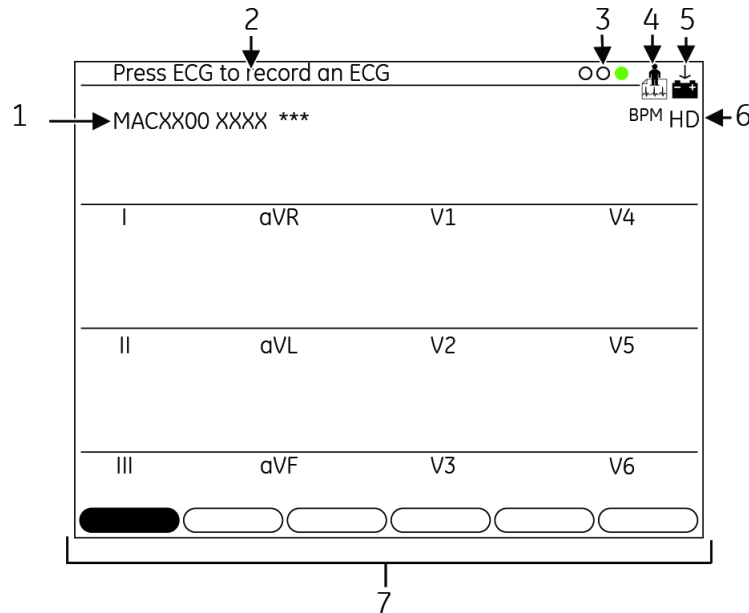

	Name	Description
1	Software Version	Displays the system's software version during the first few seconds of power up.
2	User Prompts	Provides additional information for the user.
3	Hookup Advisor	Displays the quality of the patient hookup. Can be turned on or off.
4	Function Icon	Indicates the Main Menu function currently being used. In this example, the Resting ECG function is being used.
5	Battery Status Icon	Indicates the status of the battery charge.
6	High Definition Pace Detection Indicator	<p>Indicates that high definition (HD) pacemaker detection is enabled. HD provides better analysis of patients with pacemakers.</p> <p>HD is an optional feature that is available if the following conditions are met:</p> <ul style="list-style-type: none"> The HDMD option has been purchased and activated. The CAM HD acquisition module is connected to the system. <p>For information on activating HD, refer to "Option Activation" on page 126.</p>
7	Menu	Provides access to additional settings or functions.

Exercise Test Screen

The following illustration is the exercise test screen.

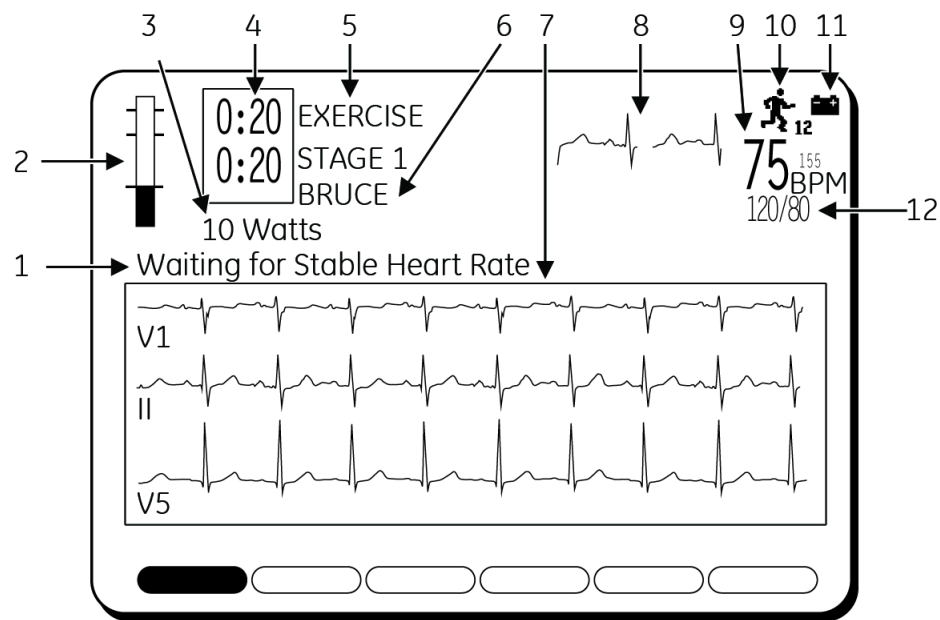

	Name	Description
1	System Messages	Provides error or other information.
2	Current Heart Rate Bar Graph	Provides a graphical representation of the patient's latest heart rate. The top horizontal line is the maximum predicted heart rate (220 - age). The line below that is the target heart rate (a percentage of 220 - age). At the start of Exercise phase, a third line displays the resting heart rate.
3	Workload Level	Indicates the units of measurement and can be changed.
4	Phase and Stage Clocks	Indicates the current duration of the phase and stage. The top clock displays the total time in a phase. The bottom clock displays the time in a stage. During the Test End phase, the top clock displays total time in the Exercise phase and the bottom clock displays total time in the Recovery phase.
5	Current Phase and Stage Name	Indicates what phase (top name) and stage (bottom name) are currently being performed.
6	Protocol Name	Identifies the name of the protocol.
7	Rhythm Formats	Displays the lead readings. Refer to Chapter 14, "System Setup" for instructions on changing the leads being displayed.
8	Medians	Displays the median of the current and pretest rhythms.





	Name	Description
9	Current Heart Rate	Displays the patient's heart rate. Determined using the three leads displayed on your screen during the pre-test phase. These leads can be changed during the test by selecting the Measurements function.
10	Function Icon	Indicates the Main Menu function currently being used. In this example, the Exercise12 function is being used.
11	Battery Status Icon	Indicates the status of the battery charge.
12	Systolic/Diastolic Blood Pressure	Displays the current systolic and diastolic blood pressure readings.

Main Menu

This section provides information about the functions available on the Main Menu and instructions on how to select functions from the Main Menu. Familiarize yourself with this information before using the MAC system.









Main Menu Functions



The following table identifies the functions available on the Main Menu. The functions displayed in your Main Menu may vary due to the installation of purchased software options.

Function	Description
 <p>Resting ECG</p>	Records a 12-lead ECG.
 <p>Pediatric ECG</p>	Records a 15-lead pediatric ECG. The standard 12 leads and the V3R, V4R, and V7 leads are used.
 <p>Vector Loops</p>	Records a 15-lead vector cardiogram. The standard 12 leads and the X,Y,Z leads are used.
 <p>15-lead ECG</p>	Records an adult 15-lead ECG. The standard 12 leads and three user-defined leads are used.

To Purchase, Visit

1-800-694-2055 Avobus.com

 <p>EditProtocol</p>	<p>Creates new or edits existing exercise test protocols. Also, a protocol can be saved, printed, or erased.</p>
 <p>Exercise 12</p>	<p>Conducts the 12-lead exercise test and allows you to print reports. This is a purchased option.</p>
 <p>Exercise 15</p>	<p>Conducts the 15-lead (12 standard, 3 user-defined leads) exercise test and allows you to print reports. This is a purchased option.</p>
 <p>Master's Step</p>	<p>Runs the Master's Step exercise protocol. (Japan only.)</p>
 <p>Hi-Res</p>	<p>Records a signal-averaged high-resolution ECG. This is a purchased option.</p>
 <p>PHI-Res</p>	<p>Records a p-wave signal-averaged high-resolution ECG. This is a purchased option.</p>
 <p>File Manager</p>	<p>Prints, edits, displays, transmits, and deletes stored ECG data.</p>
 <p>System Setup</p>	<p>Defines the operating parameters of the system.</p>
 <p>Receive</p>	<p>Receives and prints ECG data from other devices.</p>

Function	Description
<p>MUSE</p>  <p><i>Remote Query</i></p>	Requests, displays, and prints confirmed ECGs retrieved from a MUSE CV system. This is a purchased option.
 <p><i>Ord Mgr Int.</i></p>	Acquires, prints, and stores ECG orders received from a MUSE system with a Hospital Information System (HIS) interface.
 <p><i>Return</i></p>	Returns to the previous screen.

Selecting a Menu Function

You have two methods for selecting functions from the Main Menu:

- Function Keys
- Arrow Pad

Using Function Keys

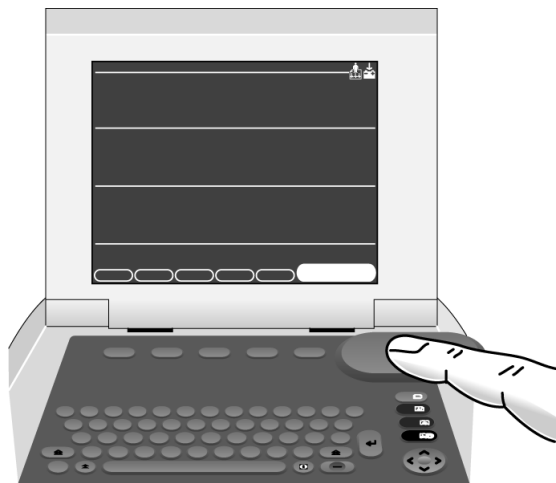

1. Press the function key directly below the menu function to be selected.
2. To display more functions on the Main Menu, press the function key directly below the **More** menu item.

Using the Arrow Pad

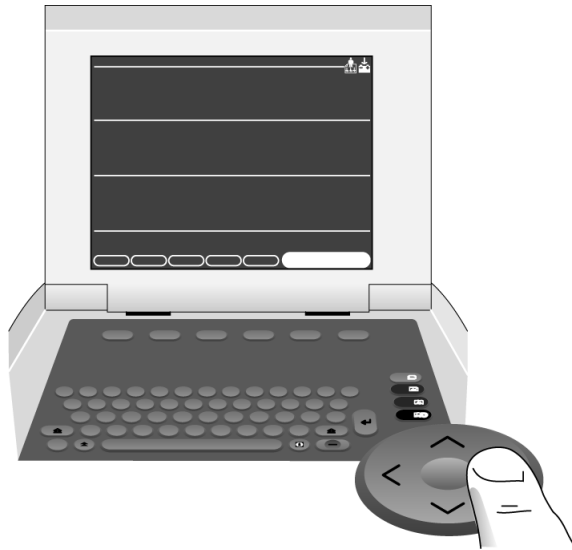

1. Press the arrow keys on the Arrow Pad until the desired menu item is highlighted.
2. Press the middle button on the Arrow Pad to select the highlighted menu item.

Report Layout

The following illustration and table describe the basic report layout. For more information about reports, refer to “ECG Reports” on page 135.

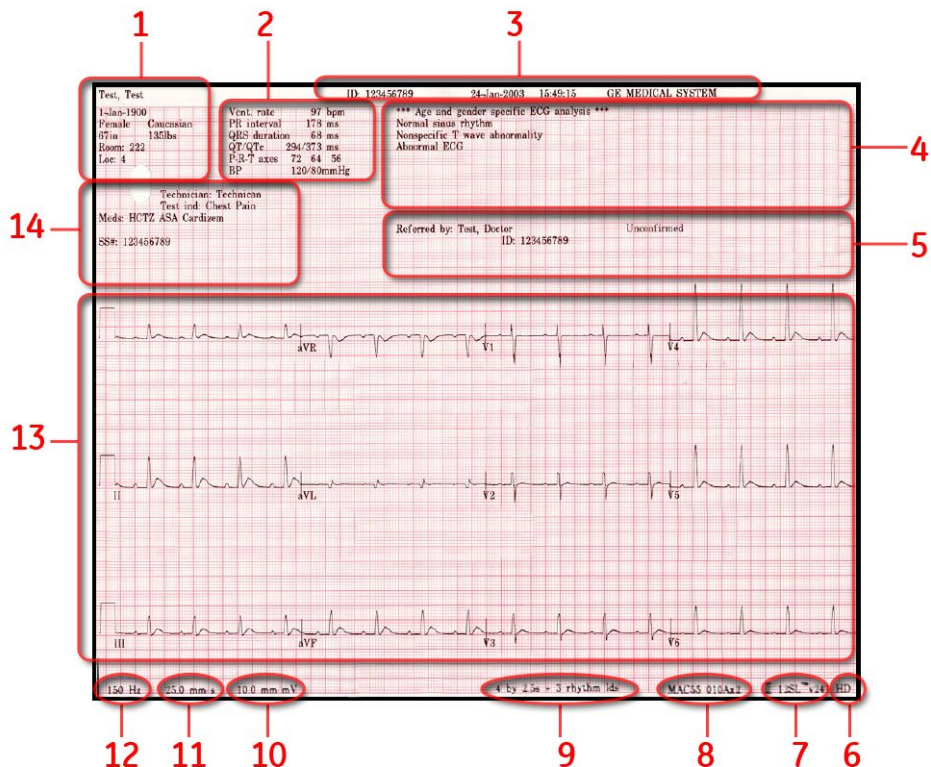

	Name	Description
1	Patient Demographics	Displays information about the patient, including patient name, birth date, gender, race, height, weight, room, and location.
2	Vital Signs	Displays information about the patient's vital signs, including heart rate, PR interval, QRS duration, QT/QTc, P-R-T axes, and blood pressure.
3	ECG Header	Displays information about the ECG, including patient ID, ECG date and time, and hospital name.
4	Messages	Displays system notifications, including 12SL interpretation (if enabled), ACI-TIPI information (if enabled), ACS information (if enabled), and critical value notifications (if enabled).
5	Report Status	Displays the status of the report and physicians.
6	HD Status	Indicates whether high definition (HD) pacemaker detection mode was used. HD mode is available only on reports generated by a MAC5500 on which HD is enabled and for ECGs acquired with a CAM HD device. It will not appear if HD was not enabled, if the ECG was not acquired with a CAM-HD, or if the report was generated on a MAC3500.
7	12SL Version	Displays the version of 12SL used to analyze the ECG. MAC version 10 uses 12SL version 22 and appears on the report as 12SL v241
8	Product Model and Software Version	Displays the product model (MAC55) and software version (010x).
9	Report Format	Displays the title of the report.
10	Gain Setting	Displays the gain setting of the ECG. Refer to "Standard ECGs" on page 73 for more information on the gain setting.
11	Speed Settings	Displays the speed setting of the ECG. Refer to "Standard ECGs" on page 73 for more information on the speed setting.
12	Filter Setting	Displays the filter setting of the ECG. Refer to "Standard ECGs" on page 73 for more information on the filter setting.
13	Waveforms	Displays the ECG waveforms. The leads and waveforms printed depend on the leads selected when conducting the test. Refer to "Standard ECGs" on page 73 for more information on the leads setting.
14	Clinical Trial Data	Displays the clinical trial data gathered during the ECG test, if the CT Data Guard option was activated and configured. Refer to "CT Data Guard" on page 142 for more information.

Entering Data

You have two methods for entering data into the MAC system:

- Typing data into a highlighted field
- Selecting data from a drop-down list

Typing Data into a Highlighted Field



1. Using the Arrow Pad, press the arrow keys to highlight the desired field.
2. Type the relevant data into the field.
3. Press either the middle button of the Arrow Pad or the **Return** key to enter the data into the field.

The cursor moves to the next data field.

Selecting Data from a Drop-down List

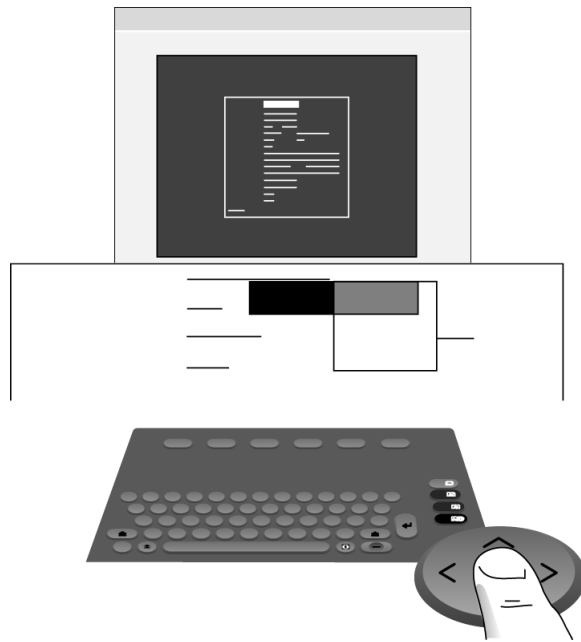

1. Using the Arrow Pad, press the arrow keys to highlight the desired field.
2. Press the middle button of the Arrow Pad.
A list of available values drops down.
3. Using the Arrow Pad, press the arrow keys to highlight the desired value.
4. Press the middle button of the Arrow Pad to select the desired value.
The value is entered into the field and the cursor moves to the next data field.

To Purchase, Visit

1-800-607-2155
Avobus.com



3

Preparing the Patient

This chapter provides the procedures for preparing the patient's skin and properly placing electrodes. Some of the procedures for placing electrodes may not apply in all cases, depending on the system and options purchased.

NOTE:

These instructions do not cover the application of electrodes for the KISS Electrode Application System (not available in the United States). To use the KISS system, see the KISS operator's manual for instructions.

Preparing the Patient's Skin

Careful skin preparation is the key to an interference-free ECG. Signal quality is indicated on the device via the Hookup Advisor indicator.

1. Select the electrode placement sites for ECG monitoring or diagnosis per the protocol specified by the hospital or physician.

Refer to [“Electrode Placement” on page 55](#) for diagrams and descriptions of electrode placement for various protocols.

2. Ensure that each site is dry, clean, and free of excessive hair.

NOTE:

Do not use solvents to clean the skin; solvents trapped under electrodes may lead to abnormal skin reactions.

3. To prepare for a stress test, do the following:

- a. Mark each electrode site with a felt tip pen.
- b. Degrease each site with a skin preparation cream.
- c. Use a mild abrasion to remove the mark left by the felt tip pen.

4. Apply electrodes to the prepared sites.

Electrodes should be placed only by a physician or ECG technician.

WARNING:

SHOCK HAZARD — Touching the conductive elements cancels the protection provided by the isolated signal input.

Ensure that conductive parts of the electrodes or lead wires do not come in contact with other conductive parts.

5. Look at the lead-check screen for indication of lead problems.

NOTE:

Use only electrodes and contact agents recommended by GE Healthcare. The signal quality on the lead-check screen is not indicated until the RA/R electrode is applied. If RA/R becomes disconnected, the system will report that all electrodes are off the patient.

To purchase, visit www.avobus.com 1-800-674-2955



1 describes various methods for placing electrodes for both resting and exercise ECGs.

CAUTION:

PROPER LEADWIRE CONNECTION — Improper connection will cause inaccuracies in the ECG.

Trace each individual leadwire from its acquisition module label to the colored connector and then to the proper electrode to ensure that it is matched to the correct label location.

Resting ECG Placement

The following methods are applicable for resting ECGs.

Standard 12 Lead Placement

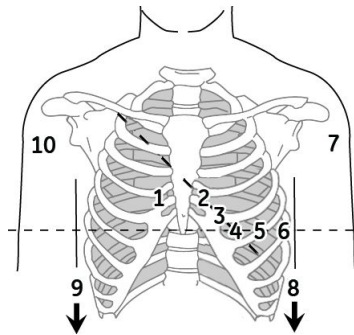

	AHA Label	IEC Label	Description
1	V1 Red	C1 Red	Fourth intercostal space at the right sternal border.
2	V2 yellow	C2 yellow	Fourth intercostal space at the left sternal border.
3	V3 green	C3 green	Midway between location 2 and 4.
4	V4 blue	C4 brown	Mid-clavicular line in the fifth intercostal space.
5	V5 orange	C5 black	Anterior axillary line on the same horizontal level as 4.
6	V6 purple	C6 purple	Mid-axillary line on the same horizontal level as 4 and 5.
7	LA black	L yellow	Left deltoid.
8	LL red	F green	Above left ankle. (Alternate placement, upper leg as close to torso as possible.)
9	RL green	N black	Above right ankle. (Alternate placement, upper leg as close to torso as possible.)
10	RA white	R red	Right deltoid.

Standard 15 Lead Placement

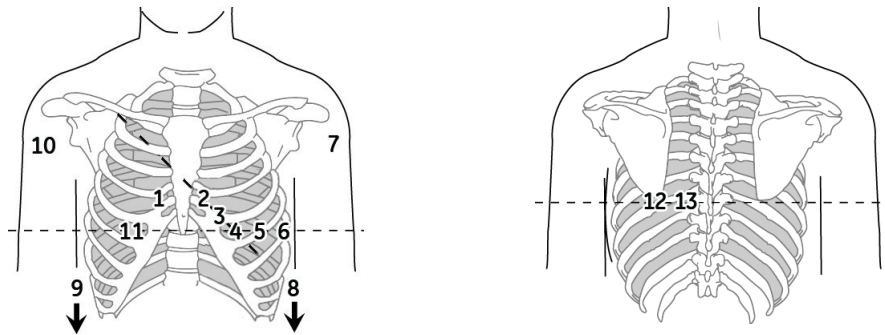

	AHA Label	IEC Label	Description
1	V1 red	C1 red	Fourth intercostal space at the right sternal border.
2	V2 yellow	C2 yellow	Fourth intercostal space at the left sternal border.
3	V3 green	C3 green	Midway between location 2 and 4.
4	V4 blue	C4 brown	Mid-clavicular line in the fifth intercostal space.
5	V5 orange	C5 black	Anterior axillary line on the same horizontal level as 4.
6	V6 purple	C6 purple	Mid-axillary line on the same horizontal level as 4 and 5.
7	LA black	L yellow	Left deltoid.
8	LL red	F green	Above left ankle. (Alternate placement, upper leg as close to torso as possible.)
9	RL green	N black	Above right ankle. (Alternate placement, upper leg as close to torso as possible.)
10	RA white	R red	Right deltoid.
11	V4R gray	C4R gray	Right anterior chest opposite of 4.
12	V8 gray	C8 gray	Under left midscapular line.
13	V9 gray	C9 gray	Left paraspinal border.

Frank X, Y, Z Placement

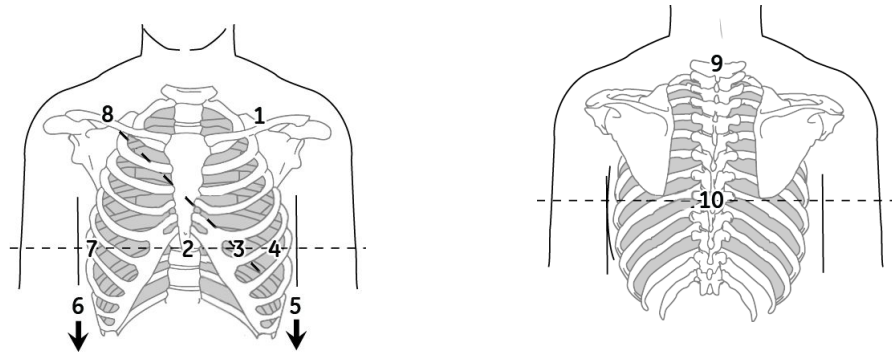

	AHA Label	IEC Label	Description
1	LA black	L yellow	Just below the clavicle of the left arm.
2	E orange	E light blue	Mid-sternum on the same horizontal level as 3 and 4.
3	V4 blue	C4 brown	Mid-clavicular line in the fifth intercostal space.
4	V6 purple	C6 purple	Mid-axillary line on the same horizontal level as 3.
5	LL red	F green	Left leg, lower abdominal quadrant.
6	RL green	N black	Right leg, lower abdominal quadrant.
7	I orange	I light blue	Right mid-axillary line on the same horizontal level as 3 and 4.
8	RA white	R red	Just below the clavicle of the right arm.
9	H orange	H light blue	Back of neck, avoid the carotid artery and jugular vein.
10	M orange	M light blue	Center of spine on the same horizontal level as 3 and 4.

To Purchase, Visit www.avobus.com 1-800-69-0055

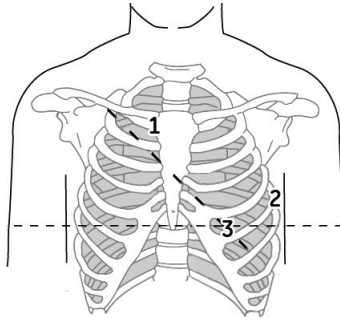

	AHA Label	IEC Label	Description
1	A1 orange	Nst white	Attachment point of the second rib to the right sternal edge.
2	A2 orange	Nax white	Fifth intercostal space on the left posterior axillary line. (Same position as V8 or C8.)
3	V4 blue	Nap white	Mid-clavicular line in the fifth intercostal space. (Same position as C4.)

Pediatric Placement

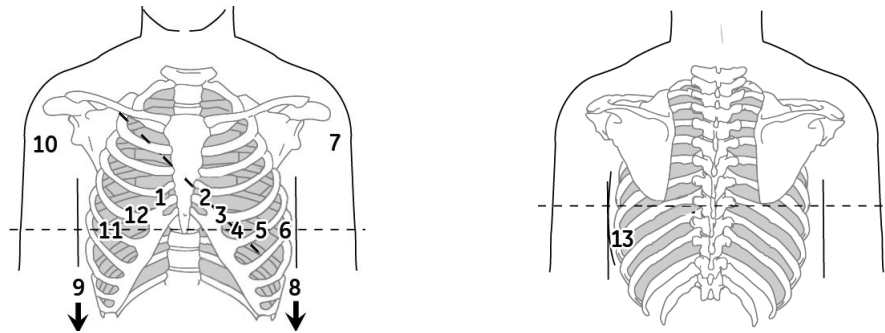

	AHA Label	IEC Label	Description
1	V1 red	C1 red	Fourth intercostal space at the right sternal border.
2	V2 yellow	C2 yellow	Fourth intercostal space at the left sternal border.
3	V3 green	C3 green	Midway between location 2 and 4.
4	V4 blue	C4 brown	Mid-clavicular line in the fifth intercostal space.
5	V5 orange	C5 black	Anterior axillary line on the same horizontal level as 4.
6	V6 purple	C6 purple	Mid-axillary line on the same horizontal level as 4 and 5.
7	LA black	LA black	Left deltoid.
8	LL red	F green	Above left ankle. (Alternate placement, upper leg as close to torso as possible.)
9	RL green	N black	Above right ankle. (Alternate placement, upper leg as close to torso as possible.)
10	RA white	R red	Right deltoid.
11	V4R gray	C4R gray	Mid-clavicular line in the fifth right intercostal space.
12	V3R gray	C3R gray	Halfway between 1 and 11.
13	V7 gray	C7 gray	Same horizontal level of 4 in the left posterior axillary line.

Exercise ECG Placement

The following methods are applicable only if the Exercise option has been enabled.

In addition to the standard electrodes, apply one electrode on the sternum (A1) and one in location V5R/C5R (A2). It is recommended that arm electrodes be placed on the patient's torso, just under the clavicles.

CM5, CC5, ML Lead Placement

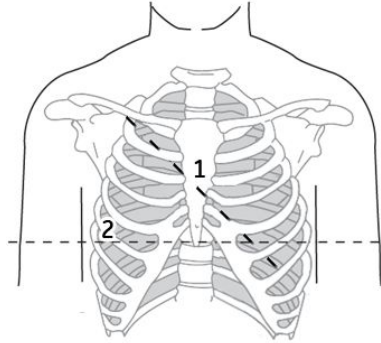

	Electrode	Description
1	A1	Mid-sternum at the second intercostal space
2	A2	In the fifth intercostal space in the right anterior axillary line (V5R/C5R).

To Purchase, Visit www.avobus.com 1-800-674-2855

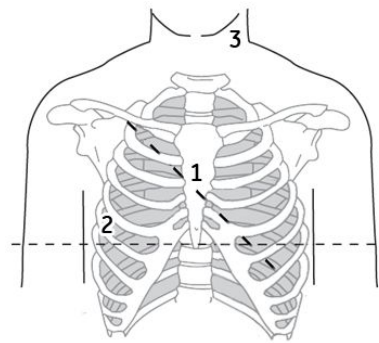

	Electrode	Description
1	A1	Mid-sternum at the second intercostal space.
2	A2	In the fifth intercostal space in the right anterior axillary line (V5R/C5R).
3	A3	On either side of the neck or anywhere above the shoulders.

4

Entering Patient Information

The first step in conducting any ECG test (resting, pediatric, 15-lead, vector loops, or exercise) is to identify the patient. Patients can be identified by manually entering the data, by bar code scanner or magnetic card reader, or by retrieving it from a MUSE CV system. This chapter describes the available methods for entering patient information and order information into the system:

- Manually entering patient information
- Reading a patient ID card
- Scanning a patient bar code
- Receiving orders from a MUSE CV system
- Manually entering orders

Some methods may not be available on all systems, depending on which options have been purchased.

CAUTION:

INACCURATE PATIENT DATA — Patient data may be retained from a previous patient. Check the patient info screen for each new patient. Data assigned to the wrong patient causes erroneous patient data that can affect diagnosis and treatment of the patient(s).

Make sure that you enter patient data for the correct patient.

NOTE:

The patient information you are required to enter depends on your system configuration. Refer to [“Patient Questions” on page 121](#) for a description of the patient information you are requested to enter.

Manually Entering Patient Information

You can manually enter patient data on all MAC systems.

1. For each new patient, select **Patient Data**.

The **Patient Data** entry window opens.

2. Using the arrow pad, navigate from field to field and enter data as appropriate.

For more information on how to manually enter data in the MAC system, refer to “Entering Data” on page 50.

NOTE:

Our equipment contains several fields that can be filled in before performing an ECG. Some of these fields must be filled in before performing an exam; others are optional and therefore left to the user to assess whether they are needed to perform the exam. The field **Race** is one of these optional fields. It has been acknowledged by the medical profession as useful to analyze some pathologies. You should be aware that, in some jurisdictions, the processing of data revealing an individual's racial origin is subject to legal requirements, such as obtaining the patient's prior consent. If you elect to collect this type of data, it is your responsibility to ensure that you comply with all applicable legal requirements.

3. If the optional **Clinical Trial Data** feature is enabled, do one of the following:
 - If the patient is part of a clinical trial, select **Yes** in the **Clinical Trial Data** field at the bottom of the **Patient Data** window.
A pop-up window opens. Enter the clinical trial information as appropriate.
 - If the patient is not part of a clinical trial, select **No** in the **Clinical Trial Data** field at the bottom of the **Patient Data** window.

See “CT Data Guard” on page 142 for information on enabling the **Clinical Trial Data** feature.

4. Select **Return** to save the patient data and return to the ECG window.

You can now begin the ECG test.

Reading a Patient Card (Option)

If the system includes the option to read a patient ID or visit card (depending on configuration), you can enter patient information by sliding the patient's magnetic card through the card reader. This section provides instructions for connecting and using the card reader.

Connecting the Card Reader

Before you can use the card reader, it must be connected to the MAC system and the system must be configured to correctly use the peripheral. Typically, this is done only once and the card reader remains attached and ready for use.

1. Connect the magnetic card reader to port A on the back panel of the system.
For information on the system ports, refer to [“Back Panel” on page 35](#).
2. Configure the card reader.
For information, refer to [“Setting Up a Card Reader” on page 156](#).

Reading a Patient ID Card

After the card reader has been set up, use the following procedure to read a patient's ID card.

1. For each new patient, select **Patient Data**.
The message **Slide the Patient ID card** or **Slide the Visit Number card** opens, depending on system configuration.
2. Slide the magnetic card through the magnetic card reader, making sure the magnetic strip is facing the correct direction.

What happens next depends on your system settings.

The system may be set up to simply load the patient data directly from the card. Or, it may be set up to use either the card's **Patient ID** or **Visit Number** to retrieve orders or ADT data. Orders may be retrieved from the local cart or from the MUSE system, while ADT information is always retrieved from the MUSE system. With this variety of options, several configuration combinations are possible. However, even with all the potential configurations, only five responses are possible:

- If the system is not configured to retrieve orders or ADT information, or if it finds no matching records, the system loads the patient information from the card and displays it in the **Patient Data** window.
Accept or modify the data as needed.
- If the system locates only one ADT record, it loads that record and displays it in the **Patient Data** window.
Accept or modify the data as needed.
- If the system locates multiple matching ADT records, it displays a list of those records.
Do one of the following:
 - Select the correct record to load its ADT information.
You can then use or modify the patient information as needed.
 - Select **Cancel** to load the patient information directly from the card.
You can then use or modify the patient information as needed.
- If the system locates one matching order, it retrieves that order.
You can then modify the order information or begin the test.
- If the system locates multiple matching orders, it displays a list of those orders.

Do one of the following:

- Select the correct order to load it.
You can then modify the order information or begin the test.
- Select **Cancel** to load the patient information directly from the card.
You can then use or modify the patient information as needed.

For information on configuring your system, refer to [Appendix E, "Creating Bar Codes and Magnetic Cards"](#).

Scanning a Bar Code (Option)

If the system includes the option to scan a bar code, you can enter patient information by scanning the bar code. This section provides instructions for connecting and using the bar code scanner.

NOTE:

Do not use the bar code reader for scanning the bar code that appears on the ECG printout. The bar code on the ECG printout is a different format and not readable by the bar code reader.

Connecting the Bar Code Scanner

Before you can use the bar code scanner, it must be connected to the MAC system and the system must be configured to correctly use the peripheral. Typically, this is done only once and the scanner remains attached and ready for use.

1. Connect the bar code scanner to port A on the back panel of the system.
For information on the system ports, refer to ["Back Panel" on page 35](#).
2. Configure the scanner.
For information, refer to ["Setting Up a Bar Code Reader" on page 158](#).

Scanning the Bar Code

After the scanner has been set up, use the following procedure to scan the bar code.

1. For each new patient, select **Patient Data**.
The message **Scan the bar code** opens.
2. Scan the bar code.

What happens next depends on your system settings.

The system may be set up to simply load the patient data directly from the bar code. Or, it may be set up to use either the bar code's **Patient ID** or **Visit Number** to retrieve orders or ADT data. Orders may be retrieved from the local cart or from the MUSE system, while ADT information is always retrieved from the MUSE system. With this variety of options, several configuration combinations are possible. However, even with all the potential configurations, only five responses are possible:

- If the system is not configured to retrieve orders or ADT information, or if it finds no matching records, the system loads the patient information from the bar code and displays it in the **Patient Data** window.

Accept or modify the data as needed.

- If the system locates only one ADT record, it loads that record and displays it in the **Patient Data** window.
Accept or modify the data as needed.
- If the system locates multiple matching ADT records, it displays a list of those records.
Do one of the following:
 - Select the correct record to load its ADT information.
You can then use or modify the patient information as needed.
 - Select **Cancel** to load the patient information directly from the bar code.
You can then use or modify the patient information as needed.
- If the system locates one matching order, it retrieves that order.
You can then modify the order information or begin the test.
- If the system locates multiple matching orders, it displays a list of those orders.
Do one of the following:
 - Select the correct order to load it.
You can then modify the order information or begin the test.
 - Select **Cancel** to load the patient information directly from the bar code.
You can then use or modify the patient information as needed.

For information on configuring your system, refer to [Appendix E, "Creating Bar Codes and Magnetic Cards"](#).

Entering Orders

The MAC system offers two methods for entering orders. This section describes both methods for entering orders and provides instructions for selecting and completing orders on the system.

Receiving Orders from a MUSE CV System (Option)

The MUSE CV System can communicate orders to this system in the following ways:

- **SD card**
This is only available with MUSE v005D or later
- **Modem**
This method works with both internal and external modems.
- **Local area network**
The MAC system must be connected to the LAN through the communications port on the right side of the MAC system.
- **Direct serial connection**
The MAC system and MUSE system can be connected using a standard serial cable.
- **Infrared**

The MUSE system's infrared device must be pointed directly at the MAC system's IR port with no obstruction, as shown in the following illustration.

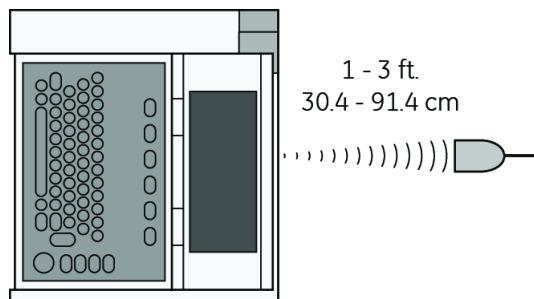

- **Wireless**

This method works with MobileLink and MobileLink UHS wireless systems. For instructions on mounting, configuring, and connecting the client bridge to the system, refer to the *MobileLink Installation and Troubleshooting Guide*.

NOTE:

Performance of the MobileLink wireless system may vary due to changes in RF (radio frequency) properties of your site or environmental conditions. If you are experiencing intermittent connectivity in certain areas of your facility, reinitiate the process of receiving from the MUSE system. Consult your hospital IT department or your local GE Healthcare networking professional regarding modification of your wireless LAN to improve system performance.

Regardless of which method(s) you use to communicate with the MUSE CV system, use the following procedure to receive orders.

1. Select **Ord Mgr Int**.
The **Order Manager Interface** opens.
2. Select **Load Orders**.
A pop-up window opens.
3. Enter the location(s) for which you want to retrieve orders.
Locations must match the locations used on the MUSE CV system. Multiple locations must be separated by commas (1, 13, 55).
4. Press **Return**.
The system connects to the MUSE system and retrieves a list of matching orders.
5. Select one or more orders and press **Return**.
The system loads and stores the selected orders.
6. Proceed to ["Selecting and Completing Orders" on page 69](#).

Manually Entering Orders

If you do not have a MUSE CV system, or cannot connect to the MUSE CV system for some reason, you can manually create the order directly on the MAC system using the following procedure.

NOTE:

The option to add orders locally must be in System Setup. Refer to “[Order Manager Interface](#)” on page 129.

1. Select **Ord Mgr Int.**
The **Order Manager Interface** opens.
2. Select **More > Create Order.**
The **Create Order** window opens.
3. Enter the order information as appropriate.
Refer to “[Entering Data](#)” on page 50 for information on how to enter data.
4. When you are done, press **Return.**
The order is saved, the entry window closes, and you return to the **Order Manager Interface** window. The new order is now available.
5. Proceed to “[Selecting and Completing Orders](#)” on page 69.

Selecting and Completing Orders

After you have orders on the system, whether they were downloaded from a MUSE CV system or created manually, use the following procedure to select and complete them.

1. Choose **Select.**
The cursor moves to the list of available orders.
2. Select the order you want to use and press **Return.**
A window opens with the order details.
3. Do one of the following:
 - To select a different order, select **Cancel.**
The detail window closes and you return to the **Order Manager Interface.**
 - To use the selected order, select **Continue.**
The appropriate ECG test window opens with the selected order. The **Patient Information** window opens with the information from the order.
4. Enter or correct the patient data.

Entering Patient Information

To Purchase, Visit

1-800-607-2155
Avobus.com



5

Recording an ECG

The method for recording an ECG varies depending on the type of ECG to be recorded. This chapter describes how to record the following ECG types:

- Standard ECGs
- Signal Averaged ECGs
- Master's Step ECGs

Some methods may not be available on your system, depending on which options have been purchased and enabled.

To assist you in recording an interference-free ECG, the MAC system provides a Hookup Advisor to alert you to troubles with the electrode connection.

NOTE:

The instructions in this chapter assume that the patient has been properly prepared and the electrodes have been placed correctly for the selected ECG type. Refer to [Chapter 3, "Preparing the Patient"](#) for details.

Hookup Advisor

The system offers the Hookup Advisor feature, which is a tool for monitoring the quality of resting ECG signals, and is available in the resting, pediatric, 15-lead, vector loops, and Master's Step applications. It can reduce or eliminate the occurrence of poor technical quality ECGs, save time, and prevent the need for retakes.

When enabled, the Hookup Advisor is displayed as a three-circle indicator in the upper right corner of the screen.

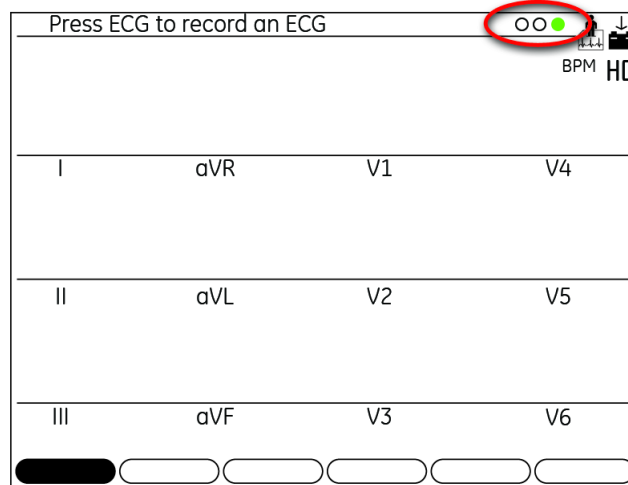

- Red indicates a lead-fail condition or extreme baseline shifts. The red indicator is always the left-most circle of the of the indicator and flashes when lit.
- Yellow indicates muscle artifact, power line interference, baseline wander, or electrode noise. The yellow indicator is always the middle circle of the of the indicator.
- Green indicates generally acceptable signal quality. The green indicator is always the right-most circle of the of the indicator.

When the lead quality is red or yellow, a message describing the lead problem or status is displayed on the screen.

Hookup Advisor is enabled and configured in the ECG Acquisition menu (**System Setup > ECG > ECG Acquisition**). Refer to [“ECG Acquisition” on page 131](#) for more information. In addition to enabling/disabling the Hookup Advisor feature, you can set the level at which the system acknowledges poor signal quality. The acknowledgement level can be set to Yellow, Red (default), or Never.

Hookup Advisor continuously reviews the ECG data for acceptable lead quality.

- If **Pre-acquisition** is enabled in the system setup, the lead quality indicator will reflect the entire previous 10 seconds of ECG data. Any displayed messages will be updated on a real-time basis to reflect adjustments/improvements to the lead quality. Once any lead quality problems have been remedied, the message **Please wait...** will be displayed until the entire 10-second period is free from lead quality problems.
- If **Pre-acquisition** is not enabled, the Hookup Advisor level and messages will respond to a fixed poor lead quality problem within two to three seconds.

When an ECG is acquired, Hookup Advisor runs a complete and more comprehensive assessment of the full 10 seconds of ECG data and possibly prompts the user regarding any poor lead quality conditions.

- If **Preview before analysis** is turned off in the system setup, a lead quality message and prompt may be displayed, depending on the current lead quality level and the

Prompt level in the system setup. If a message and prompt is displayed, the lead quality indicator will reflect the overall 10-second lead quality.

- If **Preview before analysis** is enabled, the system setup Prompt level is disregarded and the system immediately displays the Preview screen. Any lead quality messages will be displayed in this screen along with the overall 10-second lead quality indicator.

In either case, users may then do either of the following:

- Select **Continue** to continue (print the ECG).
- Select **Cancel** to cancel.

Standard ECGs

Use the following method for resting, pediatric, vector loop, and 15-lead ECGs.

1. After preparing the patient, select the correct ECG softkey.
 - To conduct a resting ECG, press **Resting ECG**.
 - To conduct a pediatric ECG, press **Pediatric ECG**.
 - To conduct a vector loops ECG, press **Vector Loops**.
 - To conduct a 15-lead ECG, press **15 lead ECG**.

The appropriate ECG test window opens.

NOTE:

All options may not be available, depending on system configuration.

2. Enter the correct patient information.
Refer to [Chapter 4, "Entering Patient Information"](#) for details.
3. Adjust the ECG settings as appropriate:
 - To select a different set of leads, press **Leads**.
A list of available leads opens:
 - **All leads** selects all the available leads.
 - **V1, II, V5** selects the identified leads.
 - **I, II, aVR, aVL, aVF** selects the identified leads.
 - **V1, V2, V3, V4, V5, V6** selects the identified leads.
 - **Lead check** conducts a check of all available leads and displays their results.
 - **Lead placement** conducts a lead check and displays a diagram of the proper placement for each lead.
 - To adjust the speed with which the waveforms are displayed, press **25 mm/s**. This opens a list of available speeds. Options include **5 mm/s**, **12.5 mm/s**, **25 mm/s**, and **50 mm/s**. This affects only the speed of the waveform as it appears on the screen and reports; it does not affect the actual speed with which the ECG is recorded. The selected value appears on the function key on the screen.
 - To adjust the gain of the ECG, press **10 mm/mV**.

This opens a list of available gains. Options include **2.5 mm/mV**, **5 mm/mV**, **10 mm/mV**, **20 mm/mV**, and **10/5**. The selected value appears on the function key on the screen.

- To adjust the filter of the printed ECG, press **150 Hz**. This opens a list of available filters. Options include **20 Hz**, **40 Hz**, **100 Hz**, and **150 Hz**. This affects only the printout; the screen filter is always set to 40 Hz. The selected value is displayed on the function key.
- To change the pacemaker enhancement, press **More > Pace Gain**. This opens the **Pacemaker Enhancement** window. Highlight **Pacemaker Enhancement**, press **Return**, and select **Yes**.
- To turn on the Acute Coronary Syndrome algorithm, press **More > ACS Off**. This opens the **ACS On/Off** window. Select **ACS On** and press **Return**.

NOTE:

ACS is an optional feature. This function key is available only if the option has been purchased and activated. Refer to [“Option Activation” on page 126](#) for instructions on activating this option.

NOTE:

ACS is activated on a per-patient basis. Settings are not retained from patient to patient; it must be activated for each patient.

4. Once all the settings have been adjusted accordingly, press **ECG**.

Any of the following may occur, depending on your system settings:

- The **ACI-TIPI Required Information** window opens. This occurs only if the optional ACI-TIPI feature is enabled. If this window opens, complete the following information:
 - **Age (18–40, 41–50, >50)**
 - **Gender (Male/Female)**
 - **Chest or Left Arm Pain**
 - Select **Chief Complaint** if the complaint of chest pain or left arm pain is the primary reason the patient is at the hospital.
 - Select **Secondary Complaint** if chest pain or left arm pain is not the primary reason the patient came to the hospital.
 - Select **Not Present** if the patient is not experiencing any chest pain or left arm pain or equivalent discomfort.

See [“ECG Acquisition” on page 131](#)) for information on enabling the optional ACI-TIPI feature.

NOTE:

If any of the information was provided on the **Patient Information** screen, you will not be asked for it here.

- The message **Acquiring data x sec** is displayed in the upper left corner of the screen. This counts down as it acquires 10 seconds of ECG data.
- A **Critical Test Result** window opens. This occurs only if (a) the optional Critical Values feature has been enabled and configured and (b) one or more of the critical values has been met. Press

Continue to close the message and continue. See “Critical Values Setup” on page 143 for more information on configuring Critical Values.

- The ECG report prints.
This occurs only if the report has been configured to print automatically. See Chapter 14, “System Setup”, for more information.
- The **Saving ECG** window flashes on the screen.
This occurs only if a report has been set to save automatically. See Chapter 14, “System Setup”, for more information.
- The ECG is transmitted to the MUSE CV system.
This occurs only if the system has been set up to transmit ECGs automatically. See Chapter 14, “System Setup”, for more information.

5. To print the ECG, press the **Print**.

6. To save the ECG, select **Store**.

This stores the ECG either to internal memory or to an external SD card, depending on whether the **SD Card Storage Only** option is enabled in **Miscellaneous Setup**.

NOTE:

This option is available only if the system was not configured to save the file automatically.

After the ECG has been stored, it can be transmitted to a MUSE system. If the system is set up to automatically transmit data, the message **Establishing network connection** will be displayed on the screen. If the system is not set up to automatically transmit data, you will need to manually initiate the transmission. Refer to Chapter 9, “Transmitting ECGs”.

7. Do one of the following:

- To take another ECG for the same patient, press **Same Pat**.
- To take an ECG for another patient, press **Next Pat**.

Signal Averaged ECGs

This is an optional method used for Hi-Res and PHi-Res ECGs.

1. Select **Hi-Res** or **PHi-Res** to enable the system to record a signal averaged ECG.

NOTE:

GE Healthcare recommends a target noise level of 0.3 μV or less when recording a PHi-Res ECG.

2. Select **Template** to initiate the signal averaged ECG recording.

3. Use the following steps to change the seed beat:

- a. Select **Display**.
- b. Select **SelectQRS**.
- c. Select a new seed beat.

4. Select **Average** to average the ECG data.

5. Select **Store** to store the ECG data.
6. You are now ready to transmit the ECG data to a MUSE system.
Refer to [Chapter 9, "Transmitting ECGs"](#) for details.

Master's Step ECGs

This is an optional test method that is available only in Japan. For information on enabling the Master's Step Exercise option, refer to "[Option Activation](#)" on page 126. For information on configuring the Master's Step Exercise, refer to "[Setting Up Master's Step Test](#)" on page 159.

1. Select **Master's Step**.
2. Enter the patient's information using the appropriate method.
Refer to [Chapter 4, "Entering Patient Information"](#) for more information.
3. Select **More > Setup**, confirm the following parameters are correct, and press **Return**.
 - **Number of steps**
 - **Test type**
 - **Post J (ms)**
 - **Step Counter Display**
 - **Sound Option**
 - **Continuous Recording**
 - **Post Exercise ECG Time**
4. Press the **ECG** button to record a pre-exercise ECG.
5. Remove the leadwires but keep the electrodes on the patient.
This prevents the patient from tripping on the leadwires during the test.
6. Press **Continue** to begin the exercise test.
7. When the patient finishes the exercise, immediately reattach the leadwires to the electrodes.
Check the waveform quality on the screen to confirm that all the leadwires were correctly reattached.
8. Press **Continue**.
The system records the ECG and prints a final report. If the system is set up to automatically store ECGs, it will also automatically store the ECG.
9. If the system is not set up to automatically store ECGs, or if it is unable to store the ECG, select **Store** to store the ECG manually.
10. You are now ready to transmit the ECG data to a MUSE system.
Refer to [Chapter 9, "Transmitting ECGs"](#) for details.

6

Exercise Stress Testing

Exercise Stress Tests are optional features that allow you to conduct ECG tests while the patient exercises on a treadmill or ergometer. For information on enabling the 12-Lead Exercise and 15-Lead Exercise options, refer to [“Option Activation” on page 126](#).

Stress tests are controlled by test protocols. Protocols consist of several phases intended to allow the patient to warm up prior to the exercise and to cool down afterward. Each phase consists of stages that incrementally adjust the intensity of the exercise. Depending on the exercise equipment used and the test protocol settings, the MAC system may automatically adjust equipment settings during a test or notify the operator when to manually adjust the settings. For more information on protocols, refer to [Chapter 7, “Editing Protocols”](#).

This chapter describes how to initiate a stress test and how to conduct each phase of the test.

Starting a Stress Test

Use the following procedure to start a stress test.

1. Prepare the patient for the test and attach the leadwires.
Refer to [Chapter 3, “Preparing the Patient”](#) for instructions.
2. Select the appropriate exercise test mode.
 - Select **Exercise12** to conduct a 12-lead test.
 - Select **Exercise15** to conduct a 15-lead test.

The corresponding ECG window opens.

3. Enter the patient information.
Refer to [Chapter 4, “Entering Patient Information”](#) for instructions on entering patient information.
4. Adjust the device settings as appropriate.
 - To adjust the writer settings, select **Writer**.
A writer setup window opens. This window allows you to turn on Arrhythmia document and cubic spline, and set the paper speed, gain, and filter for the writer. Adjust the settings as appropriate and select **Return**.
 - To change the leads, select Leads.

The **Rhythm Leads** window opens. This window allows you select the lead groups to use in the test, check lead connections, and check lead placement. Highlight the appropriate option and press **Return**.

5. After the settings have been adjusted, select **Select Proto**.
A list of available stress test protocols opens.
6. Select the desired protocol.
The selected test begins. Refer to the following sections for instructions on how to proceed during each phase of the test.

Pretest Phase

The pretest phase differs depending on the stages configured in each protocol. Commonly used stages are:

- Supine
- Standing
- Hyperventilating

If the system is configured to manually take blood pressure measurements, the system will beep and display a message when it is time to take the blood pressure. If the system is configured to take blood pressure measurements automatically, the system will take the measurements as appropriate.

You can use the **Protocol Editor** to configure the protocol to take blood pressure measurements manually or automatically. Refer to [Chapter 7, "Editing Protocols"](#).

A set of medians is saved at the end of the **Pretest** phase as the baseline medians.

1. On the stress keypad, press **12 Id** to acquire and print a baseline ECG.
2. Press **Pretest** to advance to the next pretest stage.
3. If you are using a treadmill to conduct the exercise test, tell the patient to place his/her feet on the treadmill frame, not on the belt.

WARNING:

FALLING HAZARD — Severe injury can result from a fall.

Patients should wait until the treadmill belt is moving before stepping onto the belt. Step onto the belt with one foot at a time. Avoid rapid changes in belt speed.

WARNING:

PINCH POINT HAZARD — Hair, jewelry, and loose clothing can catch in moving parts, which could result in serious injury.

Keep these and other items away from moving parts.

4. Press **Start tmill** to start the treadmill belt moving.
During the exercise test, you can adjust the test in the following ways:
 - Press **STOP tmill** once to stop the treadmill GRADUALLY.
 - Press and hold **STOP tmill** to stop the treadmill belt QUICKLY.

To Purchase, Visit  www.avobus.com 1-800-69-0055 (mounted on the treadmill) to stop



Press the **Speed W +**, **Speed W -**, and **Grade** keys to manually control the test. However, once you press these keys, the pre-programmed protocol becomes inactive: you must manually control the speed and grade during the remainder of the exercise and recovery phases.

The following menu items are available during the pretest phase of the exercise test:

Menu Item	Description
Patient Data	Enter a patient's name, ID number, and so forth. Enter the patient's age to allow your system to calculate the maximum and target heart rates.
New Protocol	Select a different exercise test protocol. This function is only available if the test will be printed only (not stored to memory).
Measurements	Reestablish the median complex, set the J point, and select the three leads used to calculate heart rate.
Leads	Select the leads used for 3 or 6 Rhythm leads, All Leads, Lead Check, or Lead Placement.
Median	Select a lead to act as the median lead. This can be a fixed lead or scanned for lead with most ST depression.
Writer	Change the writer's arrhythmia documentation (doc.), cubic spline (baseline control), paper speed, gain, filter, and writer on/off settings.

Exercise Phase

The selected protocol controls the treadmill or ergometer. When you enter the exercise phase:

- the belt speed and grade or the ergometer workload changes according to the selected protocol,
- the exercise clock (top) starts, and
- the system starts to save the test data.

WARNING:

FALLING HAZARD — Severe injury can result from a fall.

Patients should wait until the treadmill belt is moving before stepping onto the belt. Step onto the belt with one foot at a time. Avoid rapid changes in belt speed.

1. Press the **Exercise** button to begin the exercise phase.
During the test you can manually perform operations from the function keyboard.
2. Press the **Start tmill** button if the treadmill or ergometer has not been started yet.
If you are using an ergometer, the ergometer workload is automatically controlled.

The exercise test advances automatically through the exercise stages unless the operator manually overrides the test.

NOTE:

When the stages in the treadmill protocol have durations other than infinite, the exercise test advances from stage to stage automatically. However, you can press **Exercise** (on the treadmill controller keyboard) at any time to manually advance to the next exercise stage.

3. Manually adjust the treadmill's speed and grade, or the ergometer's load, as necessary.

You can adjust the speed, grade, or load in the following ways. However, once you press these keys, the pre-programmed protocol becomes inactive: you must manually control the speed and grade during the remainder of the exercise and recovery phases.

- Press **Speed W +** (to increase speed) within 5 seconds of your last workload change.
- Press **Speed W –** (to decrease speed) within 5 seconds of your last workload change.
- Press **Grade +** (to increase grade) within 5 seconds of your last workload change.
- Press **Grade –** (to decrease grade) within 5 seconds of your last workload change.

The following menu items are available during the exercise phase of the test:

Menu Item	Description
Event	Press to display a list of predefined events.
Stage Hold	Press to hold current stage.
Measurements	Reestablish the median complex, set the J point, and select the three leads used to calculate heart rate.
Leads	Select the leads used for 3 or 6 Rhythm leads, All Leads, Lead Check, or Lead Placement.
Median	Select a lead to act as the median lead. This can be a fixed lead or scanned for lead with most ST depression.
Writer	Change the writer's arrhythmia documentation (doc.), cubic spline (baseline control), paper speed, gain, filter, and writer on/off settings.

Recovery Phase

In recovery, the treadmill speed and grade or the ergometer load decreases based on the protocol configuration.

1. Press the **Recovery** button to advance to the recovery phase.
The clock begins timing the recovery phase. A maximum 12-lead measurement is taken (if that is part of the selected protocol).
2. If necessary, adjust the equipment's speed, grade, or load manually.
You can adjust the speed, grade, or load in the following ways. However, once you press these keys, the pre-programmed protocol becomes inactive: you must manually control the speed and grade during the remainder of the exercise and recovery phases.
 - Press **Speed W +** (to increase speed) within 5 seconds of your last workload change.
 - Press **Speed W –** (to decrease speed) within 5 seconds of your last workload change.
 - Press **Grade +** (to increase grade) within 5 seconds of your last workload change.
 - Press **Grade –** (to decrease grade) within 5 seconds of your last workload change.

The following menu items are available during the recovery phase of the test:

Menu Item	Description
Event	Press to display a list of predefined events.
Edit	Press during the recovery or test end phase to allow you to enter or edit patient data, reason for test termination, or comments.
Measurements	Reestablish the median complex, set the J point, and select the three leads used to calculate heart rate.
Leads	Select the leads used for Rhythm Lead 1, 2, and 3, All Leads, Lead Check, or Lead Placement.

Test End Phase

During the test end phase, the system no longer acquires or stores ECG data or displays workload, speed, or grade information.

1. Press and hold the **Test end** button to end the test and start the test end phase.
You MUST hold the **Test end** button for more than one second to activate. This prevents the test from being stopped by an accidental key press.
2. Select **Reason for termination** or **Comments** to enter information about this exercise test.

3. Select **Continue** to return to the **Test-End** menu.
 - A final report prints automatically if you selected this option in the **Edit Protocol** function (select **System Setup > Exercise Test > Final Report**).
 - To change the type of reports that print automatically, see “**Final Report**” on page 151.
4. To edit **Patient Data**, **Reason for termination**, or **Comments**, select **Edit**. You can edit this information until you select **New Patient** or **Main Menu**.
5. To print a report with the revised information, select **Reports**.

NOTE:

You can store the final exercise report to the system or to an SD card.

You must define the type of final report you want stored to your system (select **System Setup > Exercise Report > Final Report**).

The following menu items are available during the test end phase of the test:

Menu Item	Description
Edit	Press during the recovery or test end phase to allow you to enter or edit patient data, reason for test termination, or comments.
Reports	Reestablish the median complex, set the J point, and select the three leads used to calculate heart rate.
Leads	Select the leads used for Rhythm Lead 1, 2, and 3, All Leads, Lead Check, or Lead Placement.
Median	Select a lead to act as the median lead. This can be a fixed lead scanned for lead with most ST depression.
Writer	Change the writer’s arrhythmia documentation (doc.), cubic spline (baseline control), paper speed, gain, filter, and writer on/off settings.
More	Select to see More menu options.
Main Menu	Return to the system Main Menu .
New Patient	Remain in the exercise application and start a test for a new patient.

7

Editing Protocols

Protocols are scripts used to run exercise stress tests. The **Exercise Stress Test** option comes with several predefined protocols. The **Edit Protocol** function allows you to edit the predefined protocols or create new ones.

This chapter describes the protocol fields that can be modified and explains how to modify them. For information on conducting stress tests, refer to [Chapter 6, "Exercise Stress Testing"](#).

Protocol Overview

A protocol controls the duration and intensity of an exercise stress test. If used with supported exercise equipment, the protocol can automatically adjust the equipment; with unsupported equipment, the protocol can alert the tester to manually adjust the equipment.

You can modify the following protocol fields:

Protocol Parameters

Parameter	Description
Protocol Name	Displays the name of the protocol you are editing. To create a new protocol, change the name of an existing protocol.
Menu name	Determines how the protocol name appears on the screen menu.
Exercise Test Type	Determines which exercise equipment will be used during the test and, consequently, the type of test to conduct. Valid values are: <ul style="list-style-type: none">• Treadmill in MPH or Km/h Select this option for digital treadmills that can connect to and be controlled by the MAC system. You would select this option if you are using GE Healthcare's T2000 treadmill.• Analog Treadmill in MPH or Km/h Select this option for analog treadmills that cannot be connected to the MAC system. If this option is selected, the MAC system will alert the operator to manually adjust the treadmill at the appropriate points in the test.• Ergometer in Watts or KPM Select this option for digital ergometers that can connect to and be controlled by the MAC system.

Protocol Parameters (cont'd.)

Parameter	Description
Ramp Protocol	Determines how frequently the intensity of the exercise should change. <ul style="list-style-type: none"> • Select Yes if you want the ergometer workload or treadmill speed and grade to change every 6 seconds. • Select No if you want the ergometer workload or treadmill speed and grade to change with each stage change.
Name of PRETEST phase	Determines the name of the pretest phase as it will appear on your reports. The pretest phase warms up the patient and acquires baseline values.
Name of EXERCISE phase	Determines the name of the exercise phase as it will appear on your reports. The exercise phase exerts the patient and acquires target values.
Name of RECOVERY phase	Determines the name of the recovery phase as it will appear on your reports. The recovery phase cools down the patient and acquires peak values.
Name of FINAL phase	Determines the name of the final phase as it will appear on your reports. The final phase prints the final report.
Peak report style	Determines which report to print at the exercise peak, at the beginning of the recovery phase. Options include: <ul style="list-style-type: none"> • No report • 12/15 Ld • Medians • 5 Second Rhythm

Each of a protocol's four phases may consist of several stages that slowly adjust the intensity of the exercise over a period of time. The following table lists the stage fields that you can modify:

Parameter	Description
Stage	Identifies the name of the stage. Each phase can have multiple stages, except for Test End , which allows only one stage.
Duration	Sets the length of the stage in minutes and seconds. Values can range from 00:00 to 99:59, or an infinite duration. If a duration is entered, the stage automatically progresses to the next stage when the duration has passed. If an infinite duration is entered, the stage must be manually ended. The last stage always has an infinite duration and continues until you manually stop the test.
Ergometer	Sets the ergometer workload in watts or KPM: <ul style="list-style-type: none"> • Watts can range from 0 to 1000 in 5 watt increments. • KPM can range from 0 to 6000 KPM in 25 KPM increments.

Parameter	Description
Treadmill	Sets the treadmill speed in MPH or Km/h and grade in percentages. <ul style="list-style-type: none"> • MPH can range from 0.0 to 25.0 in 0.1 MPH increments. • Km/h can range from 0.0 to 40.0 Km/h in 0.1 Km/h increments • Grade can range from 0.0% to 40.0% in 0.1% increments.
Report	Sets the reports that will print and the points during the stage in which they print. You can select any of the following reports: <ul style="list-style-type: none"> • No Report • 12 Ld • Medians • 5 Second Rhythm You can also select when the first report prints and how frequently the report will be repeated during the stage.
BP	Sets when you will be prompted to record the blood pressure during the stage. You can select when the first prompt appears and how frequently the prompt will be repeated.
Median	Sets how often Median complexes are saved for the final report during the stage. You can select when the first complex is saved and how often the complex will be saved after the first complex is saved.

Editing or Creating Protocols

Use the following procedure to edit an existing protocol or create a new one.

1. From the Main Menu, select **Edit Protocol**.
2. Select a protocol to edit or <<**spare**>> to create a new protocol.
3. Edit the protocol parameters as desired.
Refer to “[Protocol Overview](#)” on page 83 for a description of the available parameters.
4. Press **Return** when you are done editing the protocol parameters.
The **Pretest** phase window opens.
5. Edit the stages of the phase as appropriate.
For more information on any of the stage fields, refer to “[Protocol Overview](#)” on page 83.

NOTE:

Some of the following options may not be available for each stage. For example, duration cannot be changed for the last stage in a phase. If you select a <<**spare**>> protocol, it has only one stage so the duration cannot be changed until additional stages are added.

- To edit the stage:
 - a. Use the arrow pad to select the stage you want to edit.

- The current stage information is displayed.
 - b. Edit the information.
 - c. When you are done, press **Return**.
- To change the duration:
 - a. Use the arrow pad to select the **Duration** field.
 - b. Enter the desired duration.
 - c. To enter an infinite duration, delete the value in the field.
 - d. When you are done, press **Return**.
- To change the exercise intensity:
 - a. Use the arrow pad to select the ergometer workload, treadmill speed, or treadmill grade, as appropriate.
 - b. Enter the desired value.
 - c. To indicate no in workload, speed, or grade, delete the value.
 - d. When you are done, press **Return**.

WARNING:

FALLING HAZARD — Severe injury can result from a fall.

Patients should wait until the treadmill belt is moving before stepping onto the belt. Step onto the belt with one foot at a time. Avoid rapid changes in belt speed.

- To change the report:
 - a. Use the arrow pad to select the **Report Style** field.
 - b. Click the arrow pad button to open the **Report Style** pop-up.
 - c. Highlight the report you want to print at this stage.
 - d. When you are done, press **Return**.
- To change Report, Median, or BP times:
 - a. Use the arrow pad to select the appropriate **First** field.
 - b. Enter the time at which you want the selected event to occur. To prevent the event from occurring, delete the value in the field.
 - c. Use the arrow pad to select the appropriate **Repeat** field.
 - d. Enter the frequency at which you want the selected event to occur. To prevent the event from recurring, delete the value in the field.
 - e. When you are done, press **Return**.
- To add another stage:
 - a. Use the arrow pad to select the stage you want to add the new stage after.
 - b. Press **Add**.
You can now use any of the previous options to edit the stage as appropriate.

6. When you are done editing the stages of the **Pretest** phase, press **Phase > Exercise**.
This opens the **Exercise** phase window.
7. Press the **Stages/Manual** function key to toggle between the **Stages** and **Manual** modes of the phase as appropriate.
8. With the **Stages** mode selected, repeat step 5 to edit the stages of the **Exercise** phase.
9. When you are done editing the stages of the **Exercise** phase, press **Phase > Recovery**.
This opens the **Recovery** phase window.
10. Repeat step 5 to edit the stages of the **Recovery** phase.
11. When you are done editing the stages of the **Recovery** phase, press **Phase > Test End**.
This opens the **Test End** phase window.
12. Select the report type to print during the **Test End** phase of the test.
Test End has only one stage, and **Report Type** is the only parameter you can modify during the phase. You have two options: **No Report** or **Final**.
13. When done, press **Menu**.
This opens a menu with the following options:
 - **Return**
 - **Edit protocol/phase names**
 - **Save current protocol**
 - **Print current protocol**
 - **Edit different protocol**
 - **Erase current protocol**
 - **Restore default protocol**
 - **Copy All to SD Card**
 - **Restore All from SD Card**
 - **Main Menu**
14. Select **Save current protocol** to save your new or revised protocol.
15. Press **Menu** to open the **Edit** menu.
16. Do one of the following:
 - To add or modify another protocol, press **Edit different protocol** and repeat from step 2.
 - To return to the main menu, press **Main Menu**.

To Purchase, Visit

1-800-607-2155
Avobus.com



8

Printing ECG Reports

The MAC system can be configured to print a report automatically during an ECG test. In addition, you can choose to reprint an ECG report in a different format during the test. Finally, you can print ECG reports that are stored on the system. This chapter explains how to print another report during the ECG test, how to print a stored ECG report, and how to store the printouts after they print.

For information on how to configure the MAC system to automatically print a report, refer to [Chapter 14, "System Setup"](#).

Printing Another Report

Use the following procedure during an ECG test to print the ECG data in a different report format.

1. Run the test.
The system automatically prints a report as configured in **System Setup**.
2. Select **More** to view the second screen of options.
3. Select **New Format**.
4. Highlight the additional report format(s) to print.
5. Press **Return**.
6. Select **Print** or press the **Copy** key to print the selected reports.

NOTE:

Changes made here affect only the current ECG. Once another ECG is recorded, the reports specified in **System Setup** are printed.

Printing Stored ECGs

Use the following procedure after an ECG test to print stored reports.

1. Press **File Manager**.
A list of stored ECG reports opens.
2. Press **Select**.
3. Select the ECG(s) to print.
4. Press **Print**.

Storing Printouts

When imaged and stored properly, ECG tracings will resist fading for several years. The expected lifespan depends on the paper. For example, GE Healthcare's Premium Thermal Recording Papers resist fading for 5–7 years. By contrast, GE Healthcare's Ultra-Archivist® Thermal Recording Papers are guaranteed to resist fading for 100 years. Refer to the documentation that accompanies your paper for its expected lifespan.

To ensure the tracing is imaged properly, the equipment must be maintained in accordance with its service manuals and technical memoranda.

To ensure the tracing lasts for the paper's expected lifespan, observe the following precautions when storing your printouts:

- Store in a cool, dark, and dry location.
Temperature must be < 80°F (27°C). Relative humidity must be < 65%.
- Avoid exposure to bright light or UV sources.
Sources of ultraviolet light include sunlight, fluorescent lights, halogen lights, mercury vapor lamps, and germicidal lamps.
- Avoid contact with cleaning fluids and solvents.
Solvents to avoid include alcohols, ketones, esters, ether, and so forth.
- Store thermal paper separately in manilla folders or polyester or polyimide protectors.
Plastic document protectors, envelopes, or sheet separators made of polystyrene, polypropylene, or polyethylene will not degrade thermal traces in themselves. However, these materials afford no protection against fading from external causes.
- Do NOT store thermal papers with any of the following:
 - carbon and carbonless forms
 - document protectors, envelopes, and sheet separators containing polyvinyl chloride or other vinyl chlorides
 - non-thermal chart papers or any other products containing tributyl phosphate, dibutyl phthalate, or any other organic solvents

NOTE:

Many medical and industrial charts contain these chemicals.

- Do NOT use mounting forms, pressure-sensitive tapes, or labels containing solvent-based adhesives.
Use only mounting forms and pressure-sensitive tapes made with starch or water-based adhesives.

If these precautions are followed, the ECG tracings should survive for the paper's expected lifespan. If the tracings show any signs of fading or deterioration, the customer must notify GE Healthcare promptly.

Transmitting ECGs

The MAC system can transmit ECGs to other MAC systems, a MUSE CV system, or a PC using any of the following methods, depending on which options have been purchased:

- Modem
- Manual Line
- Serial Line
- MUSE Network
- Ethernet Line
- Wireless

Most methods transmit ECGs in GE Healthcare's Hilltop format, but you can also choose to transmit ECGs in XML format.

The MAC system can be configured to transmit ECGs during an ECG test. However, you can also manually transmit stored ECGs at any time. This chapter explains how to manually transmit ECGs. For information on how to configure the MAC system to automatically print a report, refer to [Chapter 14, "System Setup"](#).

NOTE:

When transmitting ECGs to another MAC system, the receiving MAC system must be set up to receive the ECGs. Refer to [Chapter 10, "Receiving ECGs"](#) for details.

Transmitting ECGs via Modem

If you purchased an optional modem, you can transmit ECGs via modem. Before using the following procedure, make sure your modem is connected to an analog phone line, as shown in the following illustrations.

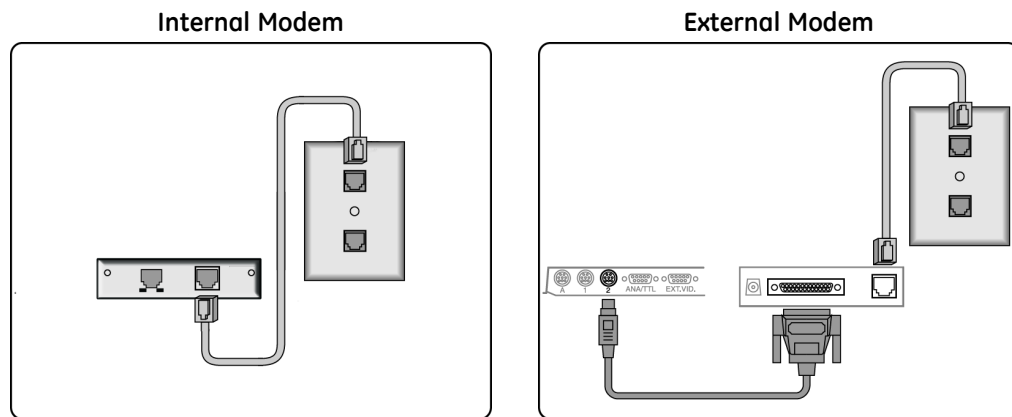

1. Select **File Manager**.
A list of ECGs opens.
2. Select **Location**.
A list of devices to which the ECG report can be transmitted opens.
3. Do one of the following
 - If the receiving device is shown, select it and continue to step 4.
 - If the receiving device is not shown, manually enter the device:
 - a. Select **Location**.
 - b. Select **Manual Dial**.
 - c. Enter the telephone number of the receiving device.
 - d. Press **Return**.
 - e. Select the modem type.
 - f. Press **Return**.
 - g. Continue to step 4.
4. Select the ECG(s) to be transmitted.
5. Select **Transmit**.

Transmitting ECGs Locally

Use the following procedure to transmit ECGs locally, that is, within the facility. Using this method, the devices must be connected via a manual line, serial line, or Ethernet line.

1. Press **File Manager**.
A list of ECGs opens.
2. Press **Location**.
A list of locations opens. Each location contains three elements:
 - **Location**

This identifies the connection method and includes the following:

- **Manual Dial**
- **Serial Line**
- **MUSE Network**
- **Ethernet Line**
- **Phone Number**
For predefined modem locations, this column will contain the location's phone number. For **Manual Dial** locations, this column will contain a question mark (?) and a phone number must be entered if the location is selected. For **Serial Line**, **MUSE Network**, and **Ethernet Line**, this column will be blank.
- **Type**
This identifies the kind of location and includes the following:
 - **MUSE Network**
 - **XML Output**
 - **ASCII Output**

3. Highlight the desired location and press **Select**.
A list of ECGs opens.
4. Select the ECG(s) to transmit.
5. Press **Transmit**.

Transmitting ECGs Wirelessly

If you purchased the MobileLink option, you can transmit ECGs wirelessly.

NOTE:

Performance of the MobileLink wireless system may vary due to changes in RF (radio frequency) properties of your site or environmental conditions. If you are experiencing intermittent connectivity in certain areas of your facility, it may be necessary to re-initiate the process of transmitting to the MUSE system. You may also wish to consult your hospital IT department or your local GE Healthcare networking professional regarding modification of your wireless LAN to improve system performance.

Before using the following procedure, connect and configure the MobileLink wireless device as described in the *MobileLink Installation and Troubleshooting Guide*.

1. Press **File Manager**.
A list of ECGs opens.
2. Press **Location**.
A list of locations opens.
3. Highlight a **Serial Line** location with a **Type** of **MUSE Network** and press **Select**.
A list of ECGs opens.
4. Select the ECG(s) to transmit.
5. Press **Transmit**.

To purchase, visit  www.avobus.com 1-800-671-2955



ods transmit ECGs in GE Healthcare's proprietary Hilltop format. You can, however, use the following procedure to transmit ECGs in XML to a PC; the data can then be extracted for analysis.

1. Connect the serial port of the MAC system to the serial port of a PC running a terminal emulation program.
2. On the MAC system, press **File Manager**.
A list of ECGs opens.
3. Press **Location**.
A list of available locations opens.
4. Highlight a **Serial Line** location with a **Type** of **XML Output** and press **Select**.
A list of ECGs opens.
5. Select the ECG(s) to transmit.
6. Press **Transmit**.

10

Receiving ECGs

This chapter explains how to receive ECGs from other MAC systems and from a MUSE CV system.

Receiving ECGs from Another MAC System

Chapter 9, “Transmitting ECGs”, explains how to manually transmit ECGs from one MAC system to another. However, in order to receive those ECGs on the other MAC system, the receiving system must be set up to receive them. The following sections explain how to set up the MAC system to receive ECGs from other MAC systems via modem or locally.

Receiving ECGs via Modem

If the modem option was purchased, use the following procedure to set up your MAC system to receive ECGs via the modem. Before using the following procedure, make sure your modem is connect to an analog phone line, as shown in the following illustrations.

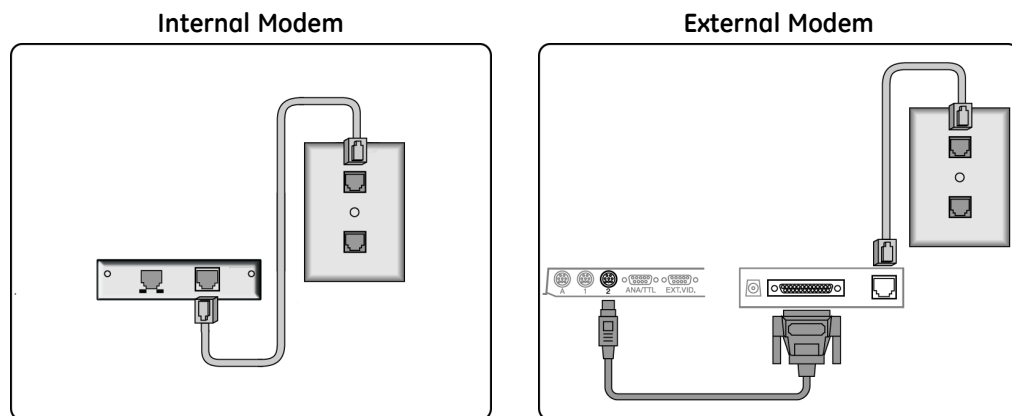

1. Select **Receive** to prepare the system for receiving ECG reports.
2. Select **Phone Line**.

The system is now ready to receive ECGs. Refer to “[Transmitting ECGs via Modem](#)” on page 91 for instructions on setting up the other MAC system to transmit ECGs via modem.

3. After all the ECGs have been received, select **Cancel** to take the system out of receiving mode.
4. Select **Main Menu**.

Receiving ECGs Locally

Use the following procedure to prepare the MAC system to receive ECGs locally, that is, from within the facility. This method receives ECGs via infrared or direct connection between the two systems. Before using this procedure, the MAC systems must be connected via their serial ports or, if using infrared, positioned as shown in the following illustration:

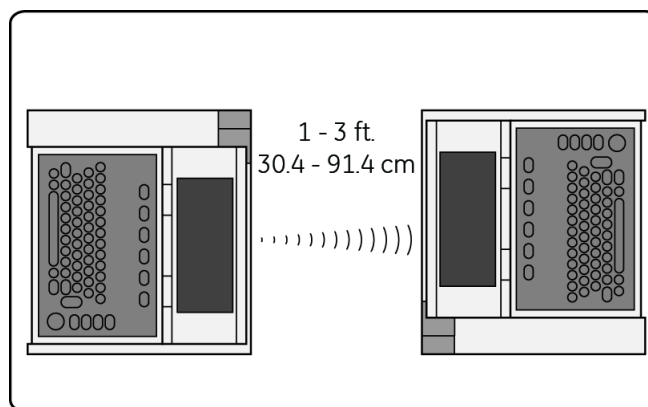

1. Select **Receive** to prepare the system for receiving ECG reports.
2. Select **Local Line**.
The system is now ready to receive ECGs. Refer to [“Transmitting ECGs Locally” on page 92](#) for instructions on setting up the other MAC system to transmit ECGs locally.
3. After all the ECGs have been received, select **Cancel** to take the system out of receiving mode.
4. Select **Main Menu**.

Receiving ECGs from a MUSE CV System

If you purchased the MUSE CV option, you can receive ECGs from any MUSE CV system. Receiving ECGs from another MAC system is passive; you receive whatever ECGs the other MAC system chooses to send. Receiving ECGs from a MUSE CV system, however, is active; you select the ECGs to receive. You can receive ECGs from a MUSE CV system using any of the following methods.

- **LAN**
This is a standard method available on all MAC systems. Before receiving ECGs via LAN, connect your MAC system to the LAN via its Ethernet port.
- **Modem**

This is a purchased option. Before receiving ECGs via modem, connect your modems as described in “Receiving ECGs via Modem” on page 95.

- **MobileLink wireless**

This is a purchased option. Before receiving ECGs via MobileLink, connect and configure the MobileLink wireless system as described in the *MobileLink Installation and Troubleshooting Guide*.

NOTE:

Performance of the MobileLink wireless system may vary due to changes in RF (radio frequency) properties of your site or environmental conditions. If you are experiencing intermittent connectivity in certain areas of your facility, it may be necessary to re-initiate the process of receiving from the MUSE system. You may also wish to consult your hospital IT department or your local GE networking professional regarding modification of your wireless LAN to improve system performance.

1. Select **Remote Query**.
2. Do one of the following:
 - To receive ECGs from the default MUSE CV system, skip to step 3.
 - To receive ECGs from a different predefined MUSE CV system, highlight the correct system in the list of predefined systems and proceed to step 3.
 - To receive ECGs from a MUSE CV system that has not been set up, do the following:
 - a. Select **Location > Manual Dial**.
 - b. Press **Return**.
 - c. Enter the telephone number of the receiving device.
 - d. Press **Return**.
 - e. For **Type**, select **MUSE Network**.
 - f. Press **Return**.
 - g. Proceed to step 3.
3. Select **Connect**.
The MAC system connects to the MUSE CV system.
4. Select an ECG by entering the patient's ID number.

NOTE:

If you do not know the patient's ID number, enter the patient's last name. You can then select the correct patient from a list of matching patients.

5. Press **Return**.
A list of matching ECGs opens.
6. Select the ECG(s) you want to retrieve.
7. Do one of the following:
 - To display the selected ECG(s), press **Display**.
The first selected ECG is displayed. You have the following options:
 - **Medians** displays the median complexes for the current ECG.
 - **Text** displays the measurements and analysis for the current ECG.

- **Rhythm** displays rhythm information for the current ECG.
- **Next** displays the next selected ECG.
- **Return** closes the display and returns to the list of ECGs.
- To print the selected ECG(s), press **Print**.
The system retrieves and prints the test(s). The report format set up in System Setup is used. Refer to [Chapter 14, "System Setup"](#), for more information.

11

Editing ECGs

While it usually not necessary to modify an ECG, the MAC system allows you to edit an ECG's demographic information, ECG measurements, and interpretive statements. After you have edited the ECG, you are prompted to save the updated file.

NOTE:

If you plan to store ECGs in XML format (see [“Transmitting ECGs in XML Format” on page 94](#)), DO NOT edit the ECGs on the MAC system. Edits made to ECGs WILL NOT BE SAVED in the XML file.

Editing Demographic Information

Anyone can edit an ECG's demographic information. This includes the patient information, medications, test information, and the ACI-TIPI chest or left arm pain data. This allows anyone to correct or update the information as necessary.

1. Press **File Manager**.
A list of ECG reports opens.
2. Press **Select**.
The cursor appears on the screen.
3. Highlight the ECG report to edit.
4. Press **Edit** to open a list of editing options.
5. Select one of the following options:
 - Patient Information
 - Medication
 - Test Information
 - ACI-TIPI Chest or Left Arm Pain

The correct fields for the selected ECG open.

6. Make the necessary corrections and press **Return**.
7. Continue to edit demographic information as necessary.
8. When you are done, press **Return** twice.
The following message is displayed:

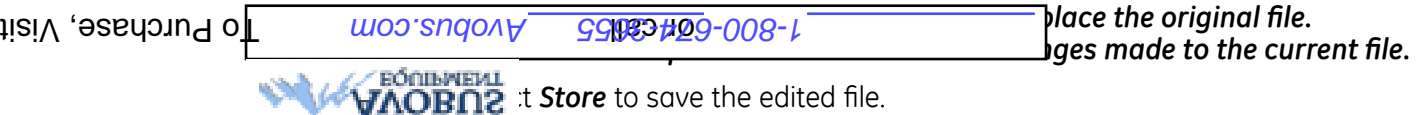

Editing ECG Measurements

Only overreaders can modify ECG measurements. You must enter an overreader's password and reviewer information before you can edit the measurements. This prevents unqualified persons from adjusting the ECG reading.

1. Press **File Manager**.
A list of ECG reports opens.
2. Press **Select**.
The cursor is displayed on the screen.
3. Highlight the ECG report to edit.
4. Press **Edit** to open a list of editing options.
5. Select one of the following options:
 - ECG Measurements
This allows you to edit resting, pediatric, or vector loop measurements.
 - Hi-Res Measurements
This allows you to edit averaged signal measurements.

You are prompted to enter the overreader password.
6. Enter the overreader password and press **Return**.
One of two things happens, depending on which option was selected:
 - If you selected **ECG Measurements**, the reviewer information fields open. Enter the reviewer information and press **Return** to display the ECG measurements to edit.
 - If you select **Hi-Res Measurements**, the **Onset** and **Offset** softkeys are displayed. Press the appropriate softkey to display the associated Hi-Res measurements to edit.
7. Select the measurement(s) to be edited and type the appropriate value.
8. When you are done, press **Return**.
9. Continue to edit measurements as necessary.
10. When you are done, press **Return** twice.
The following message is displayed:
**Select Store to save the edited file. This will replace the original file.
Select Cancel or press 'Esc' to discard the changes made to the current file.**
11. Select **Store** to save the edited file.

Editing Interpretive Statements

The MAC system automatically adds interpretive statements to ECG reports. The system allows you to edit these statements as you deem necessary. You can add, modify, join, and delete statements. You must enter an overreader's password and reviewer information before you can edit the statements. This prevents unqualified persons from adjusting the statements.

1. Press **File Manager**.
A list of ECG reports opens.
2. Press **Select**.
The cursor is displayed on the screen.
3. Highlight the ECG report to edit.
4. Press **Edit** to open a list of editing options.
5. Select **Diagnostic Statements**.
You are prompted to enter the overreader password.
6. Enter the overreader password and press **Return**.
The diagnostic statements open.
7. Select the statement to edit.
8. To add text to the beginning of the selected statement, do the following:
 - a. Press **Insert**.
The following message is displayed:
***The new statement will be inserted BEFORE the current statement.
Select statement type...***
 - b. Select the type of statement to insert.
The options are:
 - **Acronym**
 - **Freetext**
 - **Newline**
 - c. Enter a 12SL library acronym or free form text and press **Return**.
9. To add text to the end of the selected statement, do the following:
 - a. Press **Append**.
The following message is displayed:

The new statement will be inserted AFTER the current statement. Select statement type...

- b. Select the type of statement to insert.

The options are:

- ***Acronym***
- ***Freetext***
- ***Newline***

- c. Enter a 12SL library acronym or free form text and press **Return**.

10. To join the selected statement with another statement, select the second statement and press **Join**.

11. To delete the selected statement, press **Delete**.

12. Continue to edit statements as necessary.

13. When you are done, press **Return** twice.

The following message is displayed:

Select Store to save the edited file. This will replace the original file.

Select Cancel or press 'Esc' to discard the changes made to the current file.

14. Select **Store** to save the edited file.

12

Deleting ECGs and Orders

To free up storage space, the MAC system allows you to delete ECGs and uncompleted orders. This chapter describes those procedures.

Deleting ECGs

To delete ECGs, you must enter a System or Overread password, if the passwords are defined. You should only delete ECGs that have been transmitted to another ECG, a MUSE CV system, or a PC for storage.

1. Press **File Manager**.
A list of ECG reports opens.
2. Press **Select**.
The cursor is displayed on the screen.
3. Highlight the ECG report(s) to delete.
4. Press **Delete**.
Depending on system setup, you may be prompted for a password.
5. If prompted, enter the System or Overread password.

NOTE:

The System password should only be used by the system administrator or qualified service personnel. All other users should use the Overread password.

The following message is displayed:

Warning! You have selected files for delete. This is the only warning you will receive! Do you want to delete these files?'

6. Do one of the following:
 - To delete the select ECG report(s), press **Yes**.
 - To cancel the deletion and select different reports, press **No**.

Deleting Orders

Use the following procedure to delete orders stored locally on the device.

1. From the Main Menu, select **Ord Mgr Int**.

NOTE:

Depending on the options enabled on your system, you may need to select **More** to toggle through the menu until **Ord Mgr Int** is available.

The **Order Manager Interface** window opens with a list of local orders displayed.

2. Select **Delete Orders**.

The available options on the menu change.

3. To cancel without deleting any orders, select **Cancel**.

You return to the opening set of menu options.

4. To delete one or more specific order, do the following:

- a. Press **Select**.

The cursor moves to the list of orders.

- b. Select the order(s) to delete.

To select an order, highlight it and press **Return** or the arrow pad button. Select as many orders as necessary.

Use the **Page Up** function key, **Page Down** function key, and **arrow pad** to navigate through the list of orders.

NOTE:

If you select an order that has not been processed, a window opens to ask whether you want to delete the unprocessed order. Select **Yes** to continue with the unprocessed order. Select **No** to cancel the selection.

- c. When all the orders are selected, select **Delete**.

The message **Are you sure you want to delete the orders?** opens.

- d. Do one of the following:

- To delete the selected orders, select **Yes**.

The orders are deleted and you return to the opening set of menu options.

- To cancel the deletion, select **No**.

The orders are not deleted and you return to the opening set of menu options.

5. To delete all the orders, select **Delete All**.

The message **Are you sure you want to delete the orders?** opens.

Do one of the following:

- To delete all the orders, select **Yes**.

The orders are deleted and you return to the opening set of menu options.

- To cancel the deletion, select **No**.

The orders are not deleted and you return to the opening set of menu options.

6. To delete all the completed orders, select **Del Completed**.

The message **Are you sure you want to delete all completed orders?** opens.

Do one of the following:

- To delete all the completed orders, select **Yes**.
The orders are deleted and you return to the opening set of menu options.
- To cancel the deletion, select **No**.
The orders are not deleted and you return to the opening set of menu options.

To Purchase, Visit

1-800-607-2155
Avobus.com



13

Using an SD Card

The MAC system allows you to extend the device's storage capacity by using an external Secure Digital (SD) card. The SD Card is also used to distribute and apply software updates.

The following table compares the differences between internal storage and SD card storage. Be aware of these differences when selecting your storage option.

Internal Storage vs SD Card Storage

	Internal Storage	SD Card
Delete XML file when deleting corresponding ECG file ¹	No	Yes
Memory Status Messaging	70%..90%.. Full	SD Card Full
Copy/Restore ECG files to/from SD card	Yes	N/A
Ability to create XML file from File Manager	Yes	Yes
Save System Setup to SD Card	Yes	Yes
Ability to access orders on SD card	No	Yes

¹ System overwrites XML files with the same name.

Supported SD Cards

The system supports SD cards of the following capacity:

- 64 MB
- 128 MB
- 256 MB
- 512 MD
- 1 GB
- 2 GB

NOTE:

The system does NOT support SDHC (High Capacity) SD cards.

While cards from any manufacturer work with the system, GE Healthcare recommends and provides cards from SanDisk Corporation.

Preparing the SD Card

Before using the SD card, you must know how to lock, unlock, insert, eject, and format the card.

Locking and Unlocking the SD Card

You can lock an SD card to secure the data. Before using the SD card, unlock it by moving the lock tab into the unlocked position (1). This allows you to store data on or delete data from the card.

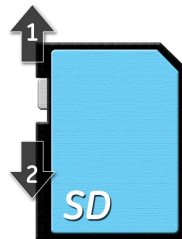

To prevent accidental deletion of data, protect the SD card by moving the lock tab into the locked position (2). The tab should remain in the locked position until you are ready to copy data to or remove data from the card.

Inserting and Ejecting the SD Card

To use the card, insert it into the card reader on the back of the MAC system. When it is properly inserted, it will snap into place.

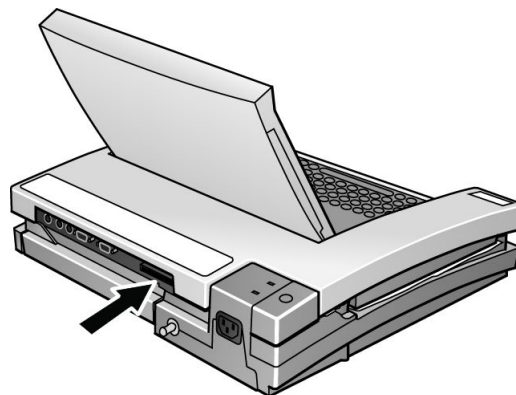

To remove the SD card from the slot, press the card into the slot; the slot is spring-loaded and will eject the SD card.

Formatting the SD Card

Most secure digital cards do not require formatting. In the event an unformatted SD card is inserted into the system, the following message will be displayed:

This SD Card cannot be read and requires formatting. Formatting will destroy all data on this SD Card. Are you sure you want to format?

Select **Yes** to format the card.

Managing Files on the SD Card

To use the SD card for external storage, use the File Manager to copy files to the card, restore files from the card, and save files in XML format to the card.

Displaying Stored ECGs

1. Power on the unit.
2. Select **File Manager**.
A list of stored ECGs is displayed.
3. Choose **Select**.
The cursor moves to the screen.
4. Highlight the ECG(s) to display.
5. Select **Display**.

Copying Files to the SD Card

Use the following procedure to copy ECGs from internal memory to the SD card. To use this option, the **SD Card Storage Only** setting must be set to **No** on the **Miscellaneous Setup** screen.

NOTE:

Copying files from internal storage to external storage deletes any files on the SD card. Be sure the SD card does not contain any files you need before continuing.

1. Insert the SD card into the system's card slot.
Refer to "Inserting and Ejecting the SD Card" on page 108.
2. Select **File Manager** to open the list of stored ECGs.
3. Select **Copy All**.
The following message is displayed:
Existing records (if any) in SD card will be deleted. Continue?
4. Do one of the following:
 - To cancel the copy, select **No**.
 - To continue copying the files, select **Yes**.
The following message is displayed:
Deleting existing records (if any) in SD card.... Please wait.
An indicator shows the progress/completion of the copying procedure.

Restoring Files from the SD Card

After files have been copied to an SD card, you can use the **Restore All** function to copy files from the SD card to internal storage.

NOTE:

If **CT Data Guard** is enabled and its **Prevent deleting of untransmitted records** field is set to **Yes**, you will receive the following warning if any of the records in internal storage have not been transmitted:

The operation deletes existing records. This cannot be done since there are untransmitted records!

If you receive this message, make sure that all records have been transmitted and try **Restore All** again.

1. Insert an SD card with ECGs into the system's card slot.
Refer to ["Inserting and Ejecting the SD Card"](#) on page 108.
2. Select **File Manager** to open the list of stored ECGs.
3. Select **Restore All**.

The following message is displayed:

Existing records (if any) in memory will be deleted. Continue?

4. Do one of the following:
 - To cancel the copy, select **No**.
 - To continue copying the files, select **Yes**.
The following message is displayed:
Deleting existing records (if any) in memory.... Please wait.
An indicator shows the progress/completion of the copying procedure.

Saving Files in XML Format

In addition to transmitting ECG records as XML files to a PC (see ["Transmitting ECGs in XML Format"](#) on page 94), the MAC system can save ECG records as XML files on an SD card.

1. Insert an SD card into the system's card slot.
Refer to ["Inserting and Ejecting the SD Card"](#) on page 108.
2. Select **File Manager** to open the list of stored ECGs.
3. Highlight the record(s) to export as XML.
4. Select **Save XML**.

The ECGs are converted to XML and saved to the SD card.

Updating Software from the SD Card

When a software update is made available for the MAC system, it is provided on an SD card. Use the following procedure to apply the update.

NOTE:

Connect the system to AC power before you begin the software update. Keep the system connected to AC power during the software update and do not power off the system during the software update.

1. Press **Power** to turn on the system.
2. From the **Main Menu**, select **System Setup**.
3. Enter the system password. and press **Enter**.
4. Press **Shift + F3**.

The following message is displayed:

Please Insert SD Card
Press 'Esc' to cancel

5. Insert the SD card.

The following message is displayed:

Current Version: xx.xx
New Software Version: yy.yy
Press 'Enter' to start update.

6. Press **Enter**.

NOTE:

If the system is not connected to AC power, the message **Please switch to AC Power** is displayed. Connect the system to an AC outlet.

A series of messages flash on the screen to indicate the installation progress. One of two things will happen:

- If the system does not need a boot code update, the following messages are displayed:

Programming Over
System is Shutting Down

The system shuts down. Skip to step 8.

- If the system needs a boot code update, the following messages are displayed:

Current Boot Version: xx.xx
New Boot Version: yy.yy
Press 'Enter' to start Installation

7. Press **Enter** to update the boot code.

The following messages are displayed:

Programming Primary Boot
Programming Over
System is Shutting Down

The system shuts down.

To Purchase, Visit

1-800-607-2155 Avobus.com



the software version has been updated.

14

System Setup

This chapter describes how to use **System Setup** to configure your system. It provides an overview of the setup process and details on how to set up:

- Automatic tasks
- System basics
- ECGs
- Signal Averaged ECGs
- Exercise Stress Tests
- Master's Step Tests
- Card Readers
- Bar Code Readers

In addition, the chapter provides an overview of the **System Setup** hierarchy and instructions on how to print, save, and restore the system settings.

System Setup Hierarchy

The following list shows the hierarchy of the device's **System Setup** menu. Use it to help you locate the system settings to configure.

- **Basic System**
 - *Miscellaneous Setup*
 - *Patient Questions*
 - *Screen Colors*
 - *Transmission*
 - *Network Setup*
 - *Option Activation*
 - *Date and Time*
 - *Language*
 - *Power Up Options*

- *Order Manager Interface*
- *Input Method Select*
- **ECG**
 - *ECG Acquisition*
 - *ECG Analysis*
 - *Patient Questions*
 - *Writer Setup*
 - *Resting ECG Reports*
 - Report Leads
 - Confirmed Reports
 - Unconfirmed Reports
 - *Pediatric ECG Reports*
 - Report Leads
 - Confirmed Reports
 - Unconfirmed Reports
 - *15 Lead Reports*
 - Extra Leads
 - Report Leads
 - Confirmed Reports
 - Unconfirmed Reports
 - *Vector Loops*
 - Vector Loops
 - Report Leads
 - Confirmed Reports
 - Unconfirmed Reports
 - *Analog Outputs*
 - *CD Data Guard Setup*
 - *Critical Values Setup*
 - Notifications Setup
 - Restore from SD Card
 - Save to SD Card
- **Exercise Tests**
 - *Miscellaneous Setup*
 - *Patient Questions*
 - *Writer Setup*
 - *12 Lead Exercise*
 - Report Leads
 - Exercise Reports

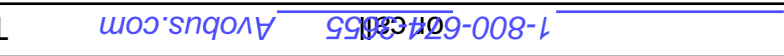

To Leads

port Leads

- Exercise Reports
- *Final Report*
- *Screen*
- *Inputs/Outputs*
- **Hi-Res**
- **Master's Step**
- **Print Setup**
- **Save Setup**
 - *To System*
 - *To SD Card*
 - *Do not save setup*
- **Restore Setup**
 - *To Original Factory Settings*
 - *From SD Card*
 - *Do Not Restore Setup*

Process Overview

The following procedure describes the basic flow and steps for using the **System Setup** function. Use this process when configuring specific settings.

1. Select **System Setup**.
You are prompted to enter the system setup password.
2. Type the system setup password and press **Return**.
The **System Setup** window opens.
3. Select the function to configure.
The selected function's settings are displayed on the screen.
4. Configure the settings as appropriate.
Refer to the corresponding function sections in this chapter for detailed descriptions of the settings.
5. When you are done configuring the section, select **Save Setup**.
A list of options is displayed.
6. Do one of the following:
 - To save the settings to internal storage, select **To system**.
Use this option to enable the changes on the system.
 - To save the settings to external storage, select **To SD Card**.

Use this option if you want to use the settings to quickly configure other MAC systems. Be sure that an SD card is inserted into the system's card slot.

- To cancel, select **Do not save setup**.

7. Select **Main Menu** to exit **System Setup**.

Setting Up Automatic Tasks

The MAC system can be configured to perform the following tasks automatically:

- Power up into a specific function
- Preview the ECG before analysis
- Print a resting ECG report
- Print a signal averaged ECG report
- Perform ACI-TIPI Interpretation
- Store an ECG
- Transmit an ECG report

Setting Up Power Up Function

You can set up the system to start up into the function you use most often.

1. Log into the **System Setup** function.
Refer to [“Process Overview” on page 115](#).
2. Select **Basic System**.
3. Select **Power Up Options**.
4. Select the function you want the system to load on startup.
For more information, refer to [“Power Up Options” on page 129](#).
5. Press **Return**.

Setting Up ECG Preview

Preview allows you to review the ECG on screen before it is printed or stored. After the ECG is displayed, you can select **Continue** to print or store the ECG or **Cancel** to discard it.

1. Log into the **System Setup** function.
Refer to [“Process Overview” on page 115](#).
2. Select **ECG**.
The ECG options are displayed.
3. Select **ECG Analysis**.
The analysis options are displayed.
4. In the **Preview before analysis** field, select **Yes**.
5. Press **Return**.

Setting Up Resting ECG Report Printing

This option allows you to select the report format that will print for different resting ECGs.

1. Log into the **System Setup** function.
Refer to [“Process Overview” on page 115](#).
2. Select **ECG**.
3. Select the type of ECG reports to configure.
You have the following options:
 - Resting ECG Reports
 - Pediatric ECG Reports
 - 15-Lead Reports
 - Vector Loops Reports
4. Select **Unconfirmed Reports**.
A list of available report formats is displayed.
5. Select the type and quantity of formats to print.
6. When you are done, press **Return**.

Setting Up Automatic ECG Storing

Use the following procedure to set up the system to automatically store an ECG.

1. Log into the **System Setup** function.
Refer to [“Process Overview” on page 115](#).
2. Select **ECG > ECG Analysis > Auto ECG Storage**.
A list of options opens.
 - All ECGs
 - No ECGs
 - Only ABNORMAL ECGs
3. Select the desired option and press **Return**.

Setting Up Automatic ECG Transmission

Use the following procedure to set up the system to automatically transmit ECGs.

NOTE:

Before setting up automatic transmission, you must define the receiving device, its default location, and its transmission parameters. Refer to “Transmission” on page 124.

1. Log into the **System Setup** function.
Refer to “Process Overview” on page 115.
2. Select **ECG > ECG Analysis > Auto ECG Transmission**.
A list of options opens.
 - All ECGs
 - No ECGs
 - Only ABNORMAL ECGs
3. Select the desired option and press **Return**.
4. When you are done, press **Return**.

Setting Up Signal Averaged ECG Report Printing

This option allows you to select the report format that will print for signal averaged ECGs.

1. Log into the **System Setup** function.
Refer to “Process Overview” on page 115.
2. Select **Hi-Res**.
A list of available report formats is displayed.
3. Select the type and quantity of formats to print.
4. When you are done, press **Return**.

Setting Up ACI-TIPI Interpretation

Use the following procedure to set up the system to automatically prompt you for ACI-TIPI information required for interpretation.

1. Log into the **System Setup** function.
Refer to “Process Overview” on page 115.
2. Select **ECG**.
3. Select **ECG Analysis**.
4. Do one of the following:
 - To enable ACI-TIPI, select **Yes** in the **Enable ACI-TIPI** field.
 - To disable ACI-TIPI, select **No** in the **Enable ACI-TIPI** field.
5. When you are done, press **Return**.

Setting Up System Basics

This section describes the following basic system settings:

- Miscellaneous Setup
- Patient Questions
- Screen Colors
- Transmission
- Network Setup
- Option Activation
- Date and Time
- Language
- Order Manager Interface
- Input Method Select

Miscellaneous Setup

To configure the system's basic settings, log on to the **System Setup** screen, select **Basic System > Miscellaneous Setup**, and complete the fields described in the following table.

Miscellaneous Setup

Field	Description
<i>Institution name</i>	Enter the name of your hospital, clinic, and so on as you want it to print on reports. On most reports the institution name prints at the top.
<i>Text entry</i>	Determines how text will be entered in the system. <ul style="list-style-type: none"> • Select <i>Uppercase only</i> to type text in uppercase letters. • Select <i>Upper and lowercase</i> to type text in upper and lowercase letters.
<i>Speaker volume</i>	Determines how loud the system speaker will be. <ul style="list-style-type: none"> • Select <i>Low</i> to set the system's speaker to low volume. • Select <i>High</i> to set the system's speaker to high volume.
<i>External video port</i>	To use an external monitor with the system, select one of the following options. <ul style="list-style-type: none"> • Select <i>Option 1</i> for most remote monitors. • Select <i>Option 2</i> if your monitor does not work with <i>Option 1</i>.
<i>Information line</i>	Determines whether additional help will be displayed on the screen. <ul style="list-style-type: none"> • Select <i>Yes</i> to display the Additional Information line on the screen. • Select <i>No</i> to hide the Additional Information line.
<i>Cart number</i>	Distinguishes this unit from other MAC systems. Enter a unique number.

Miscellaneous Setup (cont'd.)

Field	Description
Site number	Identifies the site where the unit is located. This corresponds with a site number used by the MUSE CV system with which this unit communicates. Valid values range from 1–254, inclusive.
Location number	Identifies the location where the unit is located. This corresponds with the locations on the MUSE CV system with which this unit communicates. Valid values range from 0–9999, inclusive.
File Manager sort	Determines the method the File Manager uses to sort ECGs.
Delete after transmit	Determines whether the system will automatically delete ECGs after they are transmitted from File Manager to a receiving device. It does not delete ECGs that are transmitted automatically after acquisition. Select Yes to delete ECGs. NOTE: This setting does not apply when faxing ECGs. When an ECG is faxed, it will NOT be deleted even if this field is set to Yes . NOTE: This is NOT associated with the Auto order delete field on the Order Manager Interface Setup window, which deletes orders after they have been successfully transmitted to a receiving device.
Text on bottom	Determines whether the system will print ECG test information on the bottom of the ECG reports. Select Yes to print the ECG information on the report.
Print barcodes	Determines whether the system will print the patient information in a barcode format on the report. Select Yes to print the bar code.
Automatic Shutdown	Determines whether the system will shut down automatically after a set number of minutes if a key is not pressed. <ul style="list-style-type: none"> To disable automatic shutdown, enter 0 in the field. To enable automatic shutdown, enter the number of minutes to wait before shutdown. For example, if you enter 5 , the system will shut down automatically if a key is not pressed within 5 minutes.
Serial power always on	Determines whether the serial port will receive continuous power. Select Yes to continuously power the serial port.
System password	Prevents unauthorized persons from accessing the System Setup functions. The password must be entered to access the System Setup menus. Enter a 6-character password. The default password is SYSTEM . Keep track of all assigned passwords.

Miscellaneous Setup (cont'd.)

Field	Description
Overread password	Prevents unauthorized persons from editing or deleting ECG measurements. The password must be entered to access these functions. Enter a 6-character password. The default password is OVREAD . Keep track of all assigned passwords.
Device password	Prevents unauthorized persons from accessing the system. The password must be entered to use the system. Enter a 6-character password. By default, the password is blank. Keep track of all assigned passwords.
SD Card Storage Only	Determines where the ECGs are automatically stored. <ul style="list-style-type: none"> To store to internal storage, select No. To store to an SD card, select Yes. <p>NOTE: Any ECGs that are in internal memory storage will not be accessible when switching to SD card storage. Be sure that they have been printed and/or stored before switching to SD card storage only.</p> <p>When Yes is selected for this option, an SD card must be inserted in the SD card slot before performing many of the procedures described in this manual.</p> <p>Data access speeds may vary, depending on the SD card capacity and manufacturer. This may affect the time required to read or write ECG records and other information to the SD card.</p> <p>For more information on SD cards, refer to Chapter 13, "Using an SD Card".</p>

Patient Questions

To configure the prompts that are displayed when you select **Patient Data** in the Resting ECG application, log on to the **System Setup** screen, select **Basic System > Patient Questions**, and complete the fields described in the following table.

Patient Questions

Field	Description
ID Required	Determines whether you must enter the Patient ID before an ECG can be recorded. <ul style="list-style-type: none"> Select Yes to require the ID. Select No to make the ID optional.
ID length	Determines the maximum length of the Patient ID. It must match the same length of the Patient ID in the MUSE CV system to which the MAC system communicates. Enter any number from 3 – 16 .

Patient Questions (cont'd.)

Field	Description
Age	<p>Determines the method the system uses to enter the patient's age. Select one of the following values:</p> <ul style="list-style-type: none"> • Date of birth Select this option to enter the patient's birth date in day-month-year format. The system will calculate the patient's age. • Age in years Select this option to enter the patient's age in years, months, weeks, days, or hours. <p>Your selection also affects the way in which the patient's age is printed on the report when data is transferred from a card reader or order manager.</p>
Gender	Determines whether the system will prompt you for the patient's gender. Select Yes to prompt for gender.
Height	Determines whether the system will prompt you for the patient's height. Select Yes to prompt for height.
Weight	Determines whether the system will prompt you for the patient's weight. Select Yes to prompt for weight.
Height/Weight in	<p>Determines the unit or measurement in which height and weight are measured.</p> <ul style="list-style-type: none"> • Select in./lb. to measure the height in inches and weight in pounds. • Select cm./kg. to measure the height in centimeters and the weight in kilograms.
Race	<p>Determines whether the system will prompt for the patient's race. Select Yes to prompt for race.</p> <p>NOTE: Race has been acknowledged by the medical profession as useful to analyze some pathologies. You should be aware that, in some jurisdictions, the processing of data revealing an individual's racial origin is subject to legal requirements, such as obtaining the patient's prior consent. If you elect to collect this type of data, it is your responsibility to ensure that you comply with all applicable legal requirements.</p>
Blood pressure	Determines whether the system will prompt for the patient's systolic and diastolic blood pressure. Select Yes to prompt for blood pressure.
Medications	Determines whether the system will prompt you to enter any medications the patient is taking. Select Yes to prompt for medications.
Referred by name	Determines whether the system will prompt you to enter the name of the referring physician. Select Yes to prompt for this information.

Patient Questions (cont'd.)

Field	Description
Referred by number	Determines whether the system will prompt you to enter the ID number of the referring physician. Select Yes to prompt for this information. When entering the referring physician's number, enter numbers that are compatible with the MUSE CV system to which the MAC system communicates.
Test Indication	Determines whether the system will prompt for the test reason. Select Yes to prompt for the reason.
Patient History	Determines whether the system will prompt for the patient's history. Select Yes to prompt for the history.
Technician	Determines whether the system will prompt you to enter the name of the technician conducting the test. Select Yes to prompt for this information. When entering the technician's ID, enter numbers that are compatible with the MUSE CV system to which the MAC system communicates.
Tech. Required	Determines whether the technician's name is required. Select Yes to require the technician's name.
Location	Determines whether the system prompts for the test location. Select Yes to prompt for location. Enter numbers that corresponds with the locations on the MUSE CV system with which this unit communicates.
Room number	Determines whether the system prompts for the room number where the test was taken. Select Yes to prompt for room number.
Options	Determines whether the system prompts for the option number for the ECG. Select Yes to prompt for the option number. Option numbers are user-defined.
Order number	Determines whether the system prompts for the order number for the ECG. Select Yes to prompt for order number.
Secondary ID	Determines whether the system prompts for a second ID for the ECG. Select Yes to prompt for secondary ID.
Visit	Determines whether the system prompts for the Visit ID. Select Yes to prompt for the Visit number.
Extra Questions	Allows you to define custom questions to prompt for. For each question, select the type of information that can be entered: <ul style="list-style-type: none"> • Numbers and letters Allows the entry of any alphanumeric value. • Numbers only Allows the entry of numeric values only. • Yes or No Allows only Yes and No answers.

For purchase, visit www.avobus.com or call 1-800-674-2855



To change the system's screen colors, log on to the **System Setup** screen, select **Basic System > Screen Colors**, and complete the field described in the following table.

Screen Colors

Field	Description
Screen Colors	<p>Defines the system colors. Select the desired color scheme:</p> <ul style="list-style-type: none"> • Monochrome Select this option to display white elements. • Option 1 Select this option to view white, green, yellow, and red elements. • Option 2 Select this option to view white, yellow, and red elements.

Transmission

To configure the settings for transmitting ECGs, log on to the **System Setup** screen, select **Basic System > Transmission**, and complete the fields described in the following table.

Transmission Settings

Field	Description
Modem Speaker	<p>Determines whether the modem's tones are audible. Select the appropriate value:</p> <ul style="list-style-type: none"> • Select On to hear modem tones. • Select Off to silence modem tones. • Select Dialing Only to hear the modem tones only when it is dialing.
Dialtone required	Determines whether the system must be connected to a telephone line that has a dial tone. Select Yes to require a dial tone.
Dialing method	Determines the dialing method used by the telephone line.
Fax error correction	Determines whether the facsimile machine to which you transmit ECGs uses an error correction factor. Select Yes if the machine uses error correction.
Modem	<p>Identifies the type of modem being used. Valid options are:</p> <ul style="list-style-type: none"> • Autodetect • Internal • External

Transmission Settings (cont'd.)

Field	Description
, - Two second pause	Indicates you can create a two-second pause by entering a comma in a telephone number. This will force the modem to wait for a dial tone before dialing. This is useful when accessing an outside line; the pause allows time to connect to the outside line before dialing the telephone number. For example, if you enter have to dial 9 to access an outside line, entering a phone number of 9,3216788 will pause for two seconds after dialing 9 for the outside line and before dialing the telephone number 3216788.
Phone number	Identifies the telephone numbers you most frequently transmit to. Enter from one to six telephone numbers.
Location	Type a location name to identify each telephone number.
Type	Identifies the receiving device type. Valid options are: <ul style="list-style-type: none"> • MUSE NETWORK Select this option when transmitting to a MUSE CV system or another MAC system. • Fax Machine Select this option when transmitting to a facsimile machine. <p>NOTE: When faxing a batch of ECGs, the system does not transmit all the ECGs in the batch in a single fax. Instead it faxes the first ECG, hangs up, redials, and faxes the next ECG. This is its normal mode of operation.</p>
Use IR for serial line	Determines whether the system will use the serial port or infrared port. <ul style="list-style-type: none"> • To use the infrared port, select Yes. • To use the serial port, select No.
Serial line baud rate	Determines the speed to transmit data on the serial port.
Default Location	Determines the method and device to which ECGs are automatically transmitted. Select one of the following values: <ul style="list-style-type: none"> • To transmit by local infrared communication or by local cable, select Serial line (MUSE). • To transmit ASCII data to the serial port, select Serial line (ASCII out). • To transmit XML data to the serial port, select Serial line (XML out). • To transmit by LAN, select Ethernet (MUSE). <p>NOTE: Infrared communication is not available on MAC 5500 HD systems.</p> <p>If transmitting ASCII or XML data, the PC that receives XML data through the serial line must be running a terminal emulator program (for example, HyperTerminal).</p>

Network Settings

To configure the system's local area network settings, log on to the **System Setup** screen, select **Basic System > Network Setup**, and complete the fields described in the following table.

Network Settings

Field	Description
<i>IP Address</i>	Identifies the network's IP address.
<i>Subnet Mask</i>	Identifies the network's subnet mask.
<i>Gateway</i>	Identifies the network's gateway.
<i>Port Number</i>	Identifies the network's port number.

Option Activation

Use the following procedure to activate system options.

1. Log into the **System Setup** function.
Refer to [“Process Overview” on page 115](#).
2. Select **Basic System > Option Activation**.

To Purchase, Visit

www.avobus.com 1-800-674-2155

Option	Code	Description
12 Lead Exercise	ST12	Enables 12-lead stress tests.
15 Lead Exercise	ST15	Enables 15-lead stress tests.
Hi-Res	HRES	Enables QRS signal averaging.
PHi-Res	PRES	Enables P-wave signal averaging, which enhances measurement accuracy by maximizing signal fidelity.
AT Modem	MODM	Enables transmission and receipt of data over an external AT modem.
FAX Modem	FAXM	Enables transmission and receipt of data over an external FAX modem.
Interpretation	DIAG	Enables the printing of 12SL diagnosis on ECG reports.
Remote Query	RQRY	Enables you to query MUSE databases to review and print ECG reports.
ACI TIPI	TIPI	Enables ACI-TIPI analysis for resting ECGs. This analysis generates a numerical score representing the probability that the patient has acute cardiac ischemia.
Gen-12SL	GN12	Enables the use of gender and age specific interpretation criteria when generating 12SL diagnosis.
Color	COLR	Allows you select one of two color options for the display screen.
Master's Step	MAST	Enables the Master's Step stress test. Available only in Japan.
Wireless	WIFI	Enables the transmission of ECGs over a wireless network.
Bar Code Reader	BCRD	Enables collection of patient data via bar code reader.
Card Reader	MGRD	Enables collection of patient data via patient card reader.
Edit Protocol	EDPR	Allows you to edit stress test protocols.
CT Data Guard	CTDG	Enables the clinical trial and data guard features.
Ethernet LAN	ELAN	Enables you to connect to an Ethernet local area network.
HD Pacemaker Detection	HDMD	Enables the high-definition pacemaker detection function. Requires the use of the CAM HD acquisition module.

Option	Code	Description
Critical Values	CRIT	Enables the critical value function, which allows you to define custom alerts based on key ECG values. If the Critical Values function is enabled, you must configure the alerts. Refer to “Critical Values Setup” on page 143 for more information.
Acute Coronary Syndrome	ACSM	Enables the acute coronary syndrome (ACS) function. This function performs an ACS analysis on resting ECGs, vector loops ECGs, and 15-lead ECGs.

- Type the 12-digit activation code you received when you purchased the option and press **Return**.
If you enter a valid option code, an asterisk (*) will be displayed next to the option in the list, indicating it is now active.
- Repeat for each option you purchased.
- When you are done, select **Return**.

Date and Time

To configure the system's date and time, log on to the **System Setup** screen, select **Basic System > Date and Time**, and complete the fields described in the following table.

Date and Time Configuration

Field	Description
Current date	Select the current date, month, and year.
Current time	Select the current hour and minute.

Language

To configure the system's display and report language, log on to the **System Setup** screen, select **Basic System > Language**, and complete the fields described in the following table.

Language Selection

Field	Description
Select new language	Select the desired language. The language changes when you reboot the system.

Power Up Options

To configure the system's power up application, log on to the **System Setup** screen, select **Basic System > Power Up Options**, and complete the fields described in the following table.

NOTE:

For detailed instructions, refer to “Setting Up Power Up Function” on page 116.

Power Up Options

Field	Description
Power Up Application	Select the application that opens automatically when you start the system. Options are: <ul style="list-style-type: none"> • Resting ECG • Pediatric ECG • Vector Loops • 15 Lead ECG • Order Manager Interface

Order Manager Interface

To configure the system's Order Manager, log on to the **System Setup** screen, select **Basic System > Order Manager Interface**, and complete the fields described in the following table.

Order Manager Interface

Field	Description
Initial sort value	Determines how the Order Manager initially sorts the ECGs. Select one of the following values: <ul style="list-style-type: none"> • Patient name • Patient ID • Location • Time • Stat
Create orders locally	Determines whether you can manually create orders on the MAC system. Select Yes to allow manual order creation.

Order Manager Interface (cont'd.)

Field	Description
Auto order delete	<p>Determines whether the system will automatically delete orders under the following conditions:</p> <ul style="list-style-type: none"> the orders have been successfully transmitted to a receiving device, and the associated ECGs have been transmitted and deleted. <p>This field is NOT dependent on the Delete after transmit field on the Miscellaneous Setup window. Both fields operate independently.</p>
Default order locations	<p>Identifies the locations displayed on the prompt when downloading orders. This will typically be the device's location (see "Miscellaneous Setup" on page 119).</p> <p>If the device is used in multiple locations, enter multiple locations and separate them with commas: 1,3,10, and so on.</p>

Input Method

To configure the how the system's PS/2 port will be used, log on to the **System Setup** screen, select **Basic System > Input Method Select**, and complete the fields described in the following table.

Input Method

Field	Description
Patient Data Input Device	<p>Determines which device will be connected to the PS/2 port. Valid options are:</p> <ul style="list-style-type: none"> PS/2 Keyboard Card Reader Bar Code Reader Internal Keyboard
Query Configuration	<p>Determines how the input device should be configured. Valid values vary depending on the selected device.</p> <p>If you select Card Reader or Bar Code Reader, the valid options are:</p> <ul style="list-style-type: none"> Automatic Manual None <p>If you select Internal Keyboard, the valid options are:</p> <ul style="list-style-type: none"> Manual None <p>For more information on configuring the card reader or the bar code reader, refer to "Setting Up a Card Reader" on page 156 and "Setting Up a Bar Code Reader" on page 158.</p>

Setting Up ECGs

This section describes the following ECG settings:

- ECG Acquisition
- ECG Analysis
- Patient Questions
- Writer Setup
- ECG Reports
- Analog Outputs
- CT Data Guard
- Critical Values Setup

ECG Acquisition

To configure ECG acquisition, log on to the **System Setup** screen, select **ECG > ECG Acquisition**, and complete the fields described in the following table.

ECG Acquisition

Field	Description
Baseline roll filter	Removes baseline sway. The higher the settings, the more the filter smooths out wandering baseline. This filter does not distort the ST segment displays on the ECG reports.
AC filter	Removes AC line artifacts.
Disable auto gain check.	Disables the check for out of range ECG gain. Select No to enable the auto gain check. If enabled, the system will display a prompt if the gain of the recorded ECG is either too high or too low, allowing the user to manually adjust the gain.
Disable lead off check	Disables the check for leads that are disconnected. Select No to enable the check. If enabled, the system will display a message if it detects any disconnected leads.
Pacemaker pulse enhancer	Enhances the system detection of small pacemaker pulses. When enabled, the system is very sensitive and should NOT be placed close to equipment that emits high frequency radiation. High frequency radiation can interfere with pacemaker pulse detection and normal ECG acquisition. NOTE: GE Healthcare recommends that this be set to No unless it is known that the majority of this cardiograph usage will be on patients with pacemakers. The pacemaker pulse enhancement can always be enabled on a per-patient basis at the time of ECG acquisition within the resting ECG programs.
Baseline wander warning	Enables the display a message when the system detects a wandering baseline.
Muscle tremor warning	Enables the display of a message when the system detects a muscle tremor.

ECG Acquisition (cont'd.)

Field	Description
AC noise level warning	Enables the system to check for powerline interference when recording ECGs.
Hookup Advisor	Enables the Hookup Advisor option, which monitors the quality of ECG signals for resting, 15-lead, pediatric, vector loops, and Master's Step measurements. When enabled, the system overrides the settings for Baseline wander warning , Muscle tremor warning , and AC noise level warning . For more information, refer to "Hookup Advisor" on page 71.
Prompt Level	Determines the level at which the Hookup Advisor prompts users regarding patient hookup quality. This field is available only if Hookup Advisor is enabled. There are three possible settings: <ul style="list-style-type: none"> • Never The system will not prompt the user when the signal quality is poor. However, the statement ***Poor data quality, interpretation may be adversely affected will print on reports for red lead quality situations. • Yellow The system will prompt the user for both red and yellow signal quality situations. The user can then choose to continue or cancel the ECG. The statement ***Poor data quality, interpretation may be adversely affected will print on reports. • Red The default value, the system will prompt the user for red signal quality situations. The user can then choose to continue or cancel the ECG. The statement ***Poor data quality, interpretation may be adversely affected will print on reports. <p>NOTE: If Hookup Advisor and Preview before analysis are both on, this setting is disregarded because any lead quality message will be displayed when the user is prompted to continue in the preview screen.</p> <p>The generation of the statement *** Poor data quality, interpretation may be adversely affected is based on the Hookup Advisor quality level as previously described even if Hookup Advisor is not turned on. If Hookup Advisor is not turned on, the statement will be generated based on what the Hookup Advisor level would have been had it been enabled</p>
Pre-acquisition	Determines whether the system begins to acquire ECG data as soon as the leadwires are connected to a patient. If set to Yes , the system does not wait for the user to press ecg . The latest 10 seconds of ECG data is ready for analysis when this setting is enabled.

1-800-674-2055 Avobus.com



For the analysis of ECGs, log on to the **System Setup** screen, select **ECG > Analysis**, and complete the fields described in the following table.

ECG Analysis

Field	Description
Preview before analysis	Determines whether the system will display the ECG data before it analyzes it. Applies for resting, pediatric, 15-lead, and vector loops only. Select Yes to enable preview.
Screening criteria	Prevents specific 12SL statements from appearing on ECG reports. Refer to the <i>12SL Physician's Guide</i> for more information on 12SL statements.
Suppress NORMAL statement	Prevents the Normal ECG 12SL analysis statement from appearing on printed, stored, and transmitted ECG reports. Select Yes to suppress the NORMAL statement.
Suppress ABNORMAL and BORDERLINE statements	Prevents the Abnormal ECG and Borderline ECG 12SL statements from appearing on the printed, stored, and transmitted ECGs. Select Yes to suppress the statement.
Storage format	Determines the data compression format in which ECG data is stored on the MUSE CV system. The appropriate value depends on the version of the MUSE CV system: <ul style="list-style-type: none"> • 500Hz (MUSE Network) Select this option for systems running MUSE CV version 004A or later. • 500Hz DVS (MUSE Network) Select this option for systems running MUSE CV version 5D.04 or later. This allows the ECGs to be reprinted at the original resolution of the receiving device. • 250Hz This option is not available with the ACI-TIPI option.
Store XML format	Determines whether the system will automatically save ECGs in XML format in addition to the proprietary GE Healthcare Hilltop format. If this option is selected, the XML files are stored to the following path on a blank SD Card Drive: \\XML*.XML . Before setting this option, be aware of the following: <ul style="list-style-type: none"> • If storing ECGs in XML format, DO NOT allow editing ECGs at the system. Changes made to ECGs during editing WILL NOT BE SAVED to the XML file • Except for the XML suffix, the name of the XML file is the same as the name of the ECG file. • When this option is selected, the SD card will fill up more quickly due to the size of the XML files. • In XML files, waveform data is saved as numeric points.

ECG Analysis (cont'd.)

Field	Description
Auto ECG storage	Determines which ECGs are stored automatically: <ul style="list-style-type: none"> • All ECGS All ECGs are stored upon completion. • No ECGS No ECGs are stored automatically. • Only ABNORMAL ECGs Only ECGs that the 12SL interpretation mark as abnormal are stored automatically.
Auto ECG transmission	Determines which ECGs are transmitted automatically: <ul style="list-style-type: none"> • All ECGS All ECGs are transmitted upon completion. • No ECGS No ECGs are transmitted automatically. • Only ABNORMAL ECGs Only ECGs that the 12SL interpretation mark as abnormal are transmitted automatically.
Enable ACI-TIPI	Determines whether ACI-TIPI interpretation will be performed. Available only if the ACI-TIPI option has been activated.

Patient Questions

To configure the custom patient questions to ask, log on to the **System Setup** screen, select **ECG > Patient Questions**, and complete the fields described in the following table.

Patient Questions

Field	Description
Prompt	Allows you to define custom patient questions.
Type	Allows you to set the type of response for the custom patient question. Valid values are: <ul style="list-style-type: none"> • Numbers and letters Allows the entry of any alphanumeric value. • Numbers only Allows the entry of numeric values only. • Yes or No Allows only Yes and No answers.

Writer Setup

To configure the writer's behavior, log on to the **System Setup** screen, select **ECG > Writer Setup**, and complete the fields described in the following table.

Writer Setup

Field	Description
Speed	Determines the writer's default speed in millimeters per second.
Gain	Determines the writer's default gain setting in millimeters per millivolts. For example, the setting 10/5 displays limb leads at 10 mm/mV and precordial leads at 5 mm/mV.
Filter	Determines the writer's default filter setting. The default setting is 150 Hz.

ECG Reports

You can configure the reports generated for Resting ECGs, Pediatric ECGs, 15-Lead ECGs, and Vector Loops ECG. For each ECG, you can configure the:

- leads used for the reports,
- report formats used for confirmed ECGs, and
- report formats used for unconfirmed ECGs.

In addition, you can configure the extra leads used by the 15-Lead ECG reports and the settings for the Vector Loops reports.

Report Leads

The **Report Leads** settings allow you to configure the following values:

- the leads used for each standard channel
- the rhythm reporting method
- the leads used for each rhythm report lead group
- the autorhythm lead group
- the extra leads used by the CGR and RMR reports
- the leads used by the Swedish rhythm report

The settings are essentially the same for each ECG type, although the available values for each setting may differ depending on the ECG type.

Use the following instructions to select the correct Report Leads for each report type:

- **Resting ECG Report**
System Setup > ECG > Resting ECG Reports > Report Leads
- **Pediatric ECG Report**
System Setup > ECG > Pediatric ECG Reports > Report Leads
- **15 Lead ECG Report**
System Setup > ECG > 15 Lead Reports > Report Leads
- **Vector Loops ECG Report**

Report Leads



Field	Description
Standard leads	<p>Defines which leads will print for each channel. When you change a channel's lead, the new lead prints on all ECG reports including the channel.</p> <p>You can define the lead for channels 1 through 15, except for the Resting ECG Report, which includes only channels 1 through 12.</p>
Rhythm reports	<p>Defines the data that will print on the rhythm reports:</p> <ul style="list-style-type: none"> • Real time Prints the ECG data currently on the screen. • 10 sec delayed Delays the printing by 10 seconds.
Rhythm leads	<p>Defines the lead option for each of the six rhythm groups to determine the rhythm leads that print when you select the rhythm key within an application.</p> <ul style="list-style-type: none"> • Select 3 leads to define which three leads in a three-lead Rhythm report print. • Select 6 leads to define which six leads in a six-lead Rhythm report print. • Select All leads to display and print 10 seconds of data for 12 (or 15) leads. • Select Lead Check to display and print real time data for each of the 12 (or 15) leads. • Select Lead Placement to display and print real-time data for each of the 12 (or 15) leads and to display the chest electrode placement.
Autorhythm	Determines the group of rhythm leads to print on the Autorhythm report.
RMR/CGR/extra rhythm leads	Determines the rhythm lead(s) to print on the RMR and CGR reports. When you change a rhythm lead, the new lead prints on all reports that include the lead. For example, if you select V5 for RMR/CGR/extra rhythm lead 1, then the V5 waveform prints on all reports that include RMR/CGR/extra rhythm lead 1.
Swedish format rhythm leads	<p>Sets the rhythm lead(s) to print in the Swedish Format reports.</p> <p>When you change a rhythm lead, the new lead prints on all reports that include the lead. For example, if you select V5 for the Swedish format rhythm lead 1, then the V5 waveform prints on all reports that include Swedish format rhythm lead 1.</p> <p>When printing or storing 3-lead median or trend reports, the first three Swedish format rhythm leads are used. When printing or storing 6-lead median reports, all six of the Swedish format rhythm leads are used.</p>

Extra Leads

In addition to the report leads, the 15-Lead ECG Report also allows you to define the leads used by three additional electrodes. To configure the extra leads, log on to the **System Setup > ECG > 15 Lead Reports > Extra Leads**,

Extra Leads

Field	Description
Lead Set	<p>Determines the three additional leads used for 15-lead reports. You can:</p> <ul style="list-style-type: none"> • Select a predefined set of leads. <ul style="list-style-type: none"> • Right Precordial [V4r, V5r, V6r] • Posterior [V7, V8, V9] • NEHB [D, A, J] • Mixed 3 [V4r, V8, V9] • Select Custom 3 to define electrode positions for A1, A2, and A3.

Vector Loops

In addition to the report leads, the **Vector Loops Report** also allows you to configure the vector loops. To configure the vector loops, log on to **System Setup > ECG > Vector Loops ECG Reports > Vector Loops**.

Vector Loops

Field	Description
Number of copies	Determines the number of report copies that print. Enter a value from 0 to 10.
Main loop gain	Select a default value for the main loop gain in millimeters per millivolts.
Lead Z display	Select a default value for the lead z display.
Sagittal plane	Select a default value for sagittal plane.

Confirmed Reports

The **Confirmed Reports** settings allow you to configure the following values:

- number of copies to print for each format
- whether to include tic marks on the **Medians Report**
- whether to increase the median by two on the **Medians Report**
- whether to include auto gain and auto shift on the **2 by 5s Simult.** report

The settings are the same for each ECG type, except for the **Resting ECG Report**, which includes two additional report formats: **2 by 5s Simult.** and **Pharma 4 by 2.5s.**

Use the following instructions to select the correct **Confirmed Reports** for each report type:

- **Resting ECG Report**

System Setup > ECG> Resting ECG Reports > Confirmed Reports

- **Pediatric ECG Report**
System Setup > ECG > Pediatric ECG Reports > Confirmed Reports
- **15 Lead ECG Report**
System Setup > ECG> 15 Lead Reports > Confirmed Reports
- **Vector Loops ECG Report**
System Setup > ECG> Vector Loops ECG Reports > Confirmed Reports

The following table identifies the available report settings for confirmed ECGs.

Confirmed Reports Settings

Field	Description
<i>Interpretation with</i>	Available for each report format, this field determines how many copies of the report with 12SL interpretation will print. You can enter any value from 0 to 10. If you enter 0, the report will not print.
<i>Interpretation without</i>	Available for each report format except the Expanded Median report, this field determines how many copies of the report without 12SL interpretation will print. You can enter any value from 0 to 10. If you enter 0, the report will not print.
<i>Tic marks</i>	Available only for the Expanded Median report, this field determines whether tic marks will print on the report. Select Yes to include tic marks.
<i>Medians times 2</i>	Available only for the Expanded Median report, this field determines whether the medians will be doubled. Select Yes to double the medians.
<i>Auto gain</i>	Available only for the 2 by 5s Simult. report, this field determines whether the report will apply the auto gain filter. Select Yes to apply the auto gain filter.
<i>Auto shift</i>	Available only for the 2 by 5s Simult. report, this field determines whether the report will apply the auto shift filter. Select Yes to apply the auto shift filter.

The following table lists the available formats for confirmed ECGs and identifies the type of ECG for which each format is available.

Confirmed Reports Formats

Formats	Resting	Pediatric	15 Lead	Vector Loops
<i>2 by 5s</i>	Y			
<i>2 by 5s @50mm/s</i>	Y			
<i>2 by 5s + 1 rhythm ld</i>	Y			
<i>2 by 5s Simult.</i>	Y			
<i>2 by 10s</i>	Y			
<i>3 by 5s @50mm/s</i>		Y	Y	Y
<i>3 by 10s</i>		Y	Y	Y
<i>4 by 10s</i>	Y			

	Resting	Pediatric	15 Lead	Vector Loops
4 by 2.5s	Y			
4 by 2.5s + 1 rhythm Id	Y			
4 by 2.5s + 3 rhythm Ids	Y	Y	Y	Y
5 by 2s		Y	Y	Y
5 by 2s + 1 rhythm Id		Y	Y	Y
5 by 2s + 3 rhythm Ids		Y	Y	Y
5 by 10s		Y	Y	Y
12 Rhythm leads	Y			
Autorhythm	Y	Y	Y	Y
CGR	Y			
Expanded Median	Y			
Pharma 4 by 2.5s + 2 rhythm Ids	Y			
RMR	Y	Y	Y	Y
Swedish Format 1	Y			
Swedish Format 2	Y			

Unconfirmed Reports

The **Unconfirmed Reports** settings allow you to configure the following values:

- number of copies to print for each format
- whether to include tic marks on the **Medians Report**
- whether to increase the median by two on the **Medians Report**
- whether to include auto gain and auto shift on the **2 by 5s Simult.** report
- the confirmation text that will print on the reports

The formats are the same for each ECG type, except for the **Resting ECG Report**, which includes additional formats.

Use the following instructions to select the correct **Unconfirmed Reports** for each report type:

- **Resting ECG Report**
System Setup > ECG > Resting ECG Reports > Unconfirmed Reports
- **Pediatric ECG Report**
System Setup > ECG > Pediatric ECG Reports > Unconfirmed Reports
- **15 Lead ECG Report**
System Setup > ECG > 15 Lead Reports > Unconfirmed Reports
- **Vector Loops ECG Report**
System Setup > ECG > Vector Loops ECG Reports > Unconfirmed Reports

The following table identifies the available report settings for unconfirmed ECGs.

Unconfirmed Reports Settings

Field	Description
Interpretation with	Available for each report format, this field determines how many copies of the report with 12SL interpretation will print. You can enter any value from 0 to 10. If you enter 0, the report will not print.
Interpretation without	Available for each report format except the Expanded Median report, this field determines how many copies of the report without 12SL interpretation will print. You can enter any value from 0 to 10. If you enter 0, the report will not print.
Tic marks	Available only for the Expanded Median report, this field determines whether tic marks will print on the report. Select Yes to include tic marks.
Medians times 2	Available only for the Expanded Median report, this field determines whether the medians will be doubled. Select Yes to double the medians.
Auto gain	Available only for the 2 by 5s Simult. report, this field determines whether the report will apply the auto gain filter. Select Yes to apply the auto gain filter.
Auto shift	Available only for the 2 by 5s Simult. report, this field determines whether the report will apply the auto shift filter. Select Yes to apply the auto shift filter.
Confirmation text	Available only on the report for unconfirmed resting ECGs, this field contains the text that prints on the report to identify the ECG as unconfirmed. Options are Unconfirmed and Reviewed by .

The following table lists the available formats for confirmed ECGs and identifies the type of ECG for which each format is available.

Unconfirmed Reports Formats

Formats	Resting	Pediatric	15 Lead	Vector Loops
2 by 5s	Y			
2 by 5s @50mm/s	Y			
2 by 5s + 1 rhythm Id	Y			
2 by 5s Simult.	Y			
2 by 10s	Y			
3 by 5s @50mm/s		Y	Y	Y
3 by 10s		Y	Y	Y
4 by 10s¹	Y			
4 by 2.5s	Y			
4 by 2.5s + 1 rhythm Id	Y			
4 by 2.5s + 3 rhythm Ids	Y	Y	Y	Y

Unconfirmed Reports Formats (cont'd.)

Formats	Resting	Pediatric	15 Lead	Vector Loops
<i>5 by 2s</i>		Y	Y	Y
<i>5 by 2s + 1 rhythm Id</i>		Y	Y	Y
<i>5 by 2s + 3 rhythm Ids</i>		Y	Y	Y
<i>5 by 10s</i> ¹		Y	Y	Y
<i>12 Rhythm leads</i>	Y			
<i>Autorhythm</i> ¹	Y	Y	Y	Y
<i>CGR</i>	Y			
<i>Expanded Median</i> ¹	Y			
<i>Pharma 4 by 2.5s + 2 rhythm Ids</i>	Y			
<i>RMR</i>	Y	Y	Y	Y
<i>Swedish Format 1</i>	Y			
<i>Swedish Format 2</i>	Y			

Analog Outputs

To configure the output signals sent to additional equipment connected to the system, log on to the **System Setup** screen, select **ECG > Analog Outputs**, and complete the fields described in the following table.

Analog Outputs

Field	Description
<i>Fast Analog Output</i>	Determines the lead signals sent to the device. Options are: <ul style="list-style-type: none"> • <i>Not used</i> • <i>I</i> • <i>II</i> • <i>V1-V6</i>
<i>TTL Output</i>	Determines how the TTL output will be used. Options are: <ul style="list-style-type: none"> • <i>Not Used</i> • <i>QRS Detect</i>
<i>Polarity</i>	Determines the polarity of the TTL Output. Options are: <ul style="list-style-type: none"> • <i>Positive</i> • <i>Negative</i>
<i>Width</i>	Defines the width of the TTL Output signal in milliseconds. Enter a value from 4 to 48.

1. These reports are available for both normal and abnormal ECGs

1-800-674-2155
Avobus.com



	Description
Delay	Defines the delay in milliseconds for the TTL Output QRS detector signal. Enter a value from 0 to 100.
QRS Beep	Determines whether the system beeps for each QRS complex. Select On to enable the beep.

CT Data Guard

To configure the **Clinical Trial Data Guard**, log on to the **System Setup** screen, select **ECG > CT Data Guard Setup**, and complete the fields described in the following tables.

NOTE:

These settings pertain only to clinical trial usage of the system.

CT Data Guard — Clinical Trial Setup

Field	Description
Enable Clinical Trial Data	Enables the clinical trial features. Select Yes if you will use this system for clinical trials.
Project Code	Enter the code identifying the project. It can be up to 32 characters long.
Trial ID	Enter the ID of the trial. It can be up to 10 characters long.
Investigator ID	Determines whether the investigator's ID must be entered on each test. The investigator's ID can be up to 16 characters long. Select Yes to require the investigator's ID.
Visit Number	Determines whether the visit number is required on each test. Visit number can be up to six characters long. Select Yes to require the visit number.
Visit Type	Determines whether the visit type is required on each test. Select Yes to require the visit type. If you require visit type, you can edit the list of visit types. You can have up to six types, including the following preconfigured types: <ul style="list-style-type: none"> • Unknown • Scheduled • Unscheduled • Repeat • Early Termination • Follow Up

CT Data Guard — Clinical Trial Setup (cont'd.)

Field	Description
Dose Type	Determines whether the dose type is required on each test. Select Yes to require the dose type. If you require dose type, you can edit the list of dose types. You can have up to 20 types. Each type can be up to 32 characters long.
Additional Questions	Determines whether the response to additional patient questions are required on each test. Select Yes to require additional questions. If you select Yes , you can define up to five additional questions of 10 characters each. For each question, you must define one of the following response types: <ul style="list-style-type: none"> • Numbers and letters Allows the entry of any alphanumeric value. Answers can be up to 17 characters long. • Yes or No Allows only Yes and No answers.

CT Data Guard — Data Guard Features

Field	Description
Prevent editing of records	Disables editing ECG files in File Manager . Select Yes to prevent ECG editing.
Prevent deleting of untransmitted records	Disables the deletion of ECGs that have not been transmitted. Select Yes to prevent the deletion of untransmitted ECGs.
Enable record re-transmit notification	Enables a notification if users attempt to retransmit records that have already been transmitted to the MUSE CV system. Select Yes to enable the notification.

Critical Values Setup

The optional **Critical Values** function allows you to set up custom notifications for select ECG events. The notification is displayed after the ECG has been acquired, and you must acknowledge it before proceeding. They also print on the ECG reports. You can customize the notification text and select the events that trigger the notifications. For some events, you can also select the specific values that trigger the notification.

After configuring your critical values, you can save the configuration to an SD card, which you can use to restore the critical value configuration in the case of a system failure or to quickly configure other systems.

NOTE:

The **Critical Values** option must be activated before you can configure the notifications. Refer to [“Option Activation” on page 126](#) for more information.

Notifications Setup

To configure the critical value notifications, log on to the **System Setup** screen, select **ECG > Critical Values Setup**, and complete the fields described in the following tables.

Critical Values Notification Setup

Field	Description
Enabled notifications	Enables or disables the critical value notifications. Select Yes to enable the critical value notifications.
Critical values password	Defines the password required to edit the critical values notifications. Blank by default. Enter up to six characters to define the password.
Notification string	Defines the text that introduces the critical values notifications. The string immediately precedes trigger values on-screen and in reports. The default string is *** Critical Test Results: . Modify as necessary. You can enter up to 29 characters. NOTE: This is a string from the 12SL Statement Library. If you modify this string, you must make the same modification to the statement in the 12SL Statement Library on the MUSE systems that communicate with this device. This ensures that the statements match when viewing the ECGs in the MUSE system.
Adult High HR / Value	Adult High HR enables the notification for ECGs that exceed a set heart rate. Select Yes to enable Adult High HR notifications. Value identifies the trigger value in beats per minute. Adult heart rates that equal or exceed this value will trigger the notification.
Adult Low HR / Value	Adult Low HR enables the notification for ECGs that do not meet or exceed a set heart rate. Select Yes to enable Adult Low HR notifications. Value identifies the trigger value in beats per minute. Adult heart rates less than or equal to this value will trigger the notification.
Pediatric High HR / Value	Pediatric High HR enables the notification for ECGs that exceed a set heart rate. Select Yes to enable Pediatric High HR notifications. Value identifies the trigger value in beats per minute. Pediatric heart rates that meet or exceed this value will trigger the notification.
Pediatric Low HR / Value	Pediatric Low HR enables the notification for ECGs that do not meet or exceed a set heart rate. Select Yes to enable Pediatric Low HR notifications. Value identifies the trigger value in beats per minute. Pediatric heart rates less than or equal to this value will trigger the notification.
High QTc / Value	High QTc enables the notification for ECGs where the corrected QT interval exceeds a maximum duration. Select Yes to enable High QTc notifications. Value identifies the trigger value in milliseconds. Corrected QT intervals whose duration meet or exceed this value will trigger the notification.
STEMI detection	STEMI detection enables the notification for ECGs in which an ST segment elevation myocardial infarction is detected. Select Yes to enable STEMI notifications.

Critical Values Notification Setup (cont'd.)

Field	Description
Ischemia detection	Ischemia detection enables the notification for ECGs in which ischemia is detected. Select Yes to enable ischemia notifications.
AV Block detection	AV Block detection enables the notification for ECGs in which an AV block is detected. Select Yes to enable AV Block notifications.
Arrhythmia detection	Arrhythmia detection enables the notification for ECGs in which an arrhythmia is detected. Select Yes to enable arrhythmia notifications.

NOTE:

For more information on the critical values for STEMI detection, ischemia detection, AV block detection, or arrhythmia detection, refer to the *12SL Physician's Guide*.

Saving Critical Values to SD Card

Use the following procedure to save your critical value notification settings to an external SD card. You can use the card to restore the notification settings in the case of a system failure. You can also use the card to quickly configure other systems.

1. Configure your **Critical Values Notifications**.
Refer to "Notifications Setup" on page 144 for details.
2. When you are done configuring your settings, select **Return** at the bottom of the window.
This saves your settings to local memory and returns you to the **Critical Values Setup** menu.
3. Insert the SD card if necessary.
4. Select **Save to SD Card** and press **Return**.
The settings are saved to the card.
5. Eject the card and save it in a safe location or use it to configure other devices.

Restoring Critical Values from SD Card

Use the following procedure to restore your critical value notification settings from an external SD card. You can use this procedure to restore the notification settings in the case of a system failure. You can also use it to quickly configure other systems.

1. Insert the SD card with your critical value notification settings.
Refer to "Saving Critical Values to SD Card" on page 145 for details and backing up your settings to an SD card.
2. From the **Main Menu** select **System Setup > ECGs > Critical Values Setup > Restore from SD Card**.
The settings on the SD card overwrite any settings on the device.
3. Eject the card and save it in a safe location or use it to configure other devices.

Setting Up Signal Averaged ECGs

To configure how the system calculates signal averaged ECGs, log on to the **System Setup** screen, select **Hi-Res**, and complete the fields described in the following table.

NOTE:

These settings are available only if you have purchased the optional **HI-Res** or **PHI-Res** functions.

Signal Averaged ECGs

Field	Description
Analysis filter	Defines the analysis filter the Hi-Res and PHI-Res options use. GE Healthcare recommends using the 40–25Hz filter.
Averaging target	Determines which method to use to average the target.
Target Beat Count	Determines the target heart rate. Enter a value from 1 to 999. GE Healthcare recommends averaging to a minimum of 250 beats.
Target Noise Level	Determines the target level of noise in microvolts. Enter a value from 0.1 to 1.0. GE Healthcare recommends averaging a noise level of 0.3 microvolts.
Correlation Threshold	Determines the degree of correlation threshold. GE Healthcare recommends the Very High setting.
Final Report	Determines how many copies of the final report to print . Enter a value from 0 to 10.
Prompt	Allows you to define custom patient questions.
Type	Allows you to set the type of response for the custom patient question. Valid values are: <ul style="list-style-type: none"> • Numbers and letters Allows the entry of any alphanumeric value. • Numbers only Allows the entry of numeric values only. • Yes or No Allows only Yes and No answers.

Setting Up Exercise Tests

This section describes the following stress test settings:

- Miscellaneous Setup
- Patient Questions
- Writer Setup
- Exercise Reports
- Screen
- Inputs and Outputs

Miscellaneous Setup

To configure the exercise tests' basic settings, log on to the **System Setup** screen, select **Exercise Test > Miscellaneous Setup**, and complete the fields described in the following table.

Miscellaneous Setup

Field	Description
Timeout Interval	Determines how long it takes for a menu or prompt to close if it is not being used. Enter a value from 15 to 600 seconds.
Cubic Spline	Enables baseline control.
Event names:	Defines a list of event names that may be selected to label patient episodes during the stress test.
Reason for Termination:	Defines a list of reasons that may be selected to indicate why a stress test was terminated.

Patient Questions

To configure the patient's heart rate values and questions, log on to the **System Setup** screen, select **Exercise Test > Patient Question**, and complete the fields described in the following table.

Patient Questions

Field	Description
Max Pred HR	Determines whether the patient's maximum predicted heart rate must be entered.
Target Heart Rate	Determines whether the patient's target heart rate must be entered. Enter a percentage of the maximum predicted heart rate.
Extra Questions	<p>Defines two additional patient questions to ask during the test. For each question, you must select the type of valid response:</p> <ul style="list-style-type: none"> • Numbers and letters Allows the entry of any alphanumeric value. • Numbers only Allows the entry of numeric values only. • Yes or No Allows only Yes and No answers.

1-800-671-2155 Avobus.com



To configure the writer settings for exercise tests, log on to the **System Setup** screen, click **Exercise Test > Writer Setup**, and complete the fields described in the following table.

Writer Setup

Field	Description
Speed	Determine the writer's default speed in millimeters per second.
Gain	Determines the writer's default gain setting in millimeters per millivolts. For example, the setting 10/5 displays limb leads at 10 mm/mV and precordial leads at 5 mm/mV.
Filter	Determines the writer's default filter setting. The default is 150 Hz.
Arrhythmia Doc.	Determines whether a report will print whenever an arrhythmia occurs during the exercise test.
Tic marks	Enables tic marks on the E, J, and J+ measurement points. The value for the J+ point is set using the Post J field.
ST Measurements	Enables ST Measurements on the display and printout.
Post J	Defines the location, in milliseconds, after the J point where the ST Measurement is to be taken. Enter a value from 0 to 200.
Writer	Enables or disables the writer for the exercise test.

Exercise Reports

You can configure the reports generated for 12 Lead Exercise/Stress ECGs, 15 Lead Exercise/Stress ECGs, and Final Report. For each ECG, you can configure the:

- leads used for the reports,
- formats used for the reports, and
- settings for the final report.

In addition, you can configure the extra leads used by the 15 Lead Exercise report.

Report Leads

The **Report Leads** settings allow you to configure the following values:

- the leads used for each standard channel
- the rhythm reporting method
- the leads used for each rhythm report lead group
- the autorhythm lead group
- the extra leads used by the CGR and RMR reports
- the leads used by the Swedish rhythm report
- the method used for the median report

The settings are essentially the same for each ECG type, although the available values for each setting may differ depending on the ECG type.

Use the following instructions to select the correct **Report Leads** for each report type:

- **12 Lead Exercise Report**
System Setup > Exercise Test > 12 Lead Exercise > Report Leads
- **15 Lead Exercise Report**
System Setup > Exercise Test > 15 Lead Exercise > Report Leads

Report Leads

Field	Description
Standard leads	<p>Defines which leads will print for each channel. When you change a channel's lead, the new lead will print on all exercise reports that include the channel.</p> <p>For the 12 Lead Exercise Reports, you can define the lead for channels 1 through 12. For the 15 Lead Exercise Reports, you can define the lead for channels 1 through 15.</p>
Rhythm reports	<p>Defines the data displayed on the rhythm reports:</p> <ul style="list-style-type: none"> • Real time Prints the ECG data currently on the screen. • 10 sec delayed Delays the printing by 10 seconds.
Rhythm leads	<p>Defines the lead option for each of the six rhythm groups to determine the rhythm leads that print when you select the rhythm key within an application.</p> <ul style="list-style-type: none"> • Select 3 leads to define which three leads in a three-lead Rhythm report print. • Select 6 leads to define which six leads in a six-lead Rhythm report print. • Select All leads to display and print 10 seconds of data for 12 (or 15) leads. • Select Lead Check to display and print real-time data for each of the 12 (or 15) leads. • Select Lead Placement to display and print real time data for each of the 12 (or 15) leads and to display the chest electrode placement.
Autorhythm	Determines the group of rhythm leads to print on the Autorhythm report.
RMR/CGR/extra rhythm leads	Determines the rhythm lead(s) to print on the RMR and CGR reports. When you change a rhythm lead, the new lead will print on all reports that include the lead. For example, if you select V5 for RMR/CGR/extra rhythm lead 1, then the V5 waveform will print on all reports that include RMR/CGR/extra rhythm lead 1.

Report Leads (cont'd.)

Field	Description
Swedish format rhythm leads	<p>Sets the rhythm lead(s) to print in the Swedish Format reports.</p> <p>When you change a rhythm lead, the new lead will print on all reports that include the lead. For example, if you select V5 for the Swedish format rhythm lead 1, then the V5 waveform will print on all reports that include Swedish format rhythm lead 1.</p> <p>When printing or storing 3-lead median or trend reports, the first three Swedish format rhythm leads are used. When printing or storing 6-lead median reports, all six of the Swedish format rhythm leads are used.</p>
Median	<p>Sets the method for determining the median. You have two options: Fixed and Scan. If you select Fixed, you must define the lead to use.</p>

Extra Leads

In addition to the report leads, the 15 Lead Exercise Report also allows you to define the leads used by the three additional electrodes. To configure the extra leads, log on to **System Setup > Exercise Test > 15 Lead Exercise > Extra Leads**,

Extra Leads

Field	Description
Lead Set	<p>Determines the three additional leads used for 15-lead reports. You can:</p> <ul style="list-style-type: none"> • Select a predefined set of leads. <ul style="list-style-type: none"> • CML: [CM5, CC5, ML] • CMH [CM5, CC5, CH] • NEHB [D, A, J] • Frank [X, Y, Z] • Select Custom 3 to define electrode positions for A1, A2, and A3.

Exercise Reports

The **Exercise Reports** settings allow you to configure the following values:

- select the format for exercise reports
- select the format for median reports

The available formats for each field differ depending on whether you configure the 12 Lead Exercise report or the 15 Lead Exercise report.

Use the following instructions to select the correct **Confirmed Reports** for each report type:

- **12 Lead Exercise Report**
System Setup > Exercise Test > 12 Lead Exercise > Exercise Reports
- **15 Lead Exercise Report**
System Setup > Exercise Test > 15 Lead Exercise > Exercise Reports

To Purchase, Visit www.avobus.com 1-800-667-2155 for exercise reports.



Reports Settings

Field	Description
Exercise Reports	Determines which format will be used for each exercise report. Refer to the following table for a list of the available formats.
Median Report	Determines which format will be used for each median report. Options are: <ul style="list-style-type: none"> • Linked Medians • Medians & Rhythm • 6 Lead Comparative Medians & Rhythm • 12 Lead Comparative Medians & Rhythm

The following table lists the available report formats.

Exercise Reports Formats

Report Format	12 Leads	15 Leads
<i>2 by 5s</i>	Y	
<i>2 by 5s + 1 rhythm Id</i>	Y	
<i>4 by 2.5s + 1 rhythm Id</i>	Y	
<i>4 by 2.5s + 3 rhythm Ids</i>		Y
<i>4 by 2.5s</i>	Y	
<i>5 by 2s</i>		Y
<i>5 by 2s + 1 rhythm Id</i>		Y
<i>5 by 2s + 3 rhythm Id</i>		Y
<i>12 rhythm leads</i>	Y	
<i>Autorhythm</i>	Y	Y
<i>CGR</i>	Y	
<i>RMR</i>	Y	Y
<i>Swedish format 1</i>	Y	

Final Report

The **Final Report** settings allow you to configure the following values:

- storage option
- format of the final report preview
- format of the medians to include
- which reports to include in the final report

To configure the final report, select **System Setup > Exercise Test > Final Report** and complete the fields in the following table.

Final Report

Field	Description
Storage Option	Selects the method for storing the final report. Options are: <ul style="list-style-type: none"> • Store Strips and Final Report • Store Final Report Only • No storage of test data
Final Report Preview	Selects the format of the final report preview. Options are: <ul style="list-style-type: none"> • No preview report • Summary report • Tabular report • Selected median • Trend & Medians • Median report • Trend report
Summary Report	Determines how many copies of the report will print. Enter a value from 0 to 10. If you enter 0, the report will not print.
[Medians]	The field below Summary Report selects the medians to include on the Summary report. Options are Resting and Max ST Medians and Resting and Peak Medians .
Tabular Report	Determines how many copies of the report will print. Enter a value from 0 to 10. If you enter 0, the report will not print.
Selected Medians	Determines how many copies of the report will print. Enter a value from 0 to 10. If you enter 0, the report will not print.
Trend & Medians	Determines how many copies of the report will print. Enter a value from 0 to 10. If you enter 0, the report will not print.
Median Report / Leads	Determines how many copies of the report will print. Enter a value from 0 to 10. If you enter 0, the report will not print. If you enter a number greater than 0, select the leads to include on the report. Options are 3, 6, and All.
Trend Report / Leads	Determines how many copies of the report will print. Enter a value from 0 to 10. If you enter 0, the report will not print. If you enter a number greater than 0, select the leads to include on the report. Options are 3 and All.
ST/HR Loops	Determines how many copies of the report will print. Enter a value from 0 to 10. If you enter 0, the report will not print.
ST/HR Report	Determines how many copies of the report will print. Enter a value from 0 to 10. If you enter 0, the report will not print.

Screen

To configure how your exercise tests are displayed on the screen, log on to the **System Setup** screen, select **Exercise Test > Screen**, and complete the fields described in the following table.

Screen

Field	Description
Display Rhythm Medians	Determines whether the median complex is displayed in front of the Rhythm Lead 1, 2, and 3.
Screen Filter	Determines the filter to use for displaying the exercise test. Options are: <ul style="list-style-type: none"> • 20Hz • 40Hz

Inputs and Outputs

To configure the input and output signals sent to additional equipment, such as ergometers, connected to the system, log on to the **System Setup** screen, select **Exercise Test > Inputs / Outputs**, and complete the fields described in the following table.

Inputs/Outputs

Field	Description
Slow Analog Output	<p>Determines the slow analog output for controlling external exercise equipment. Options include:</p> <ul style="list-style-type: none"> • <i>Not Used</i> • <i>DC Heart Rate</i> • <i>Workload</i> • <i>Speed (x1)</i> • <i>Speed (x3)</i> • <i>Grade</i> <p>If using exercise protocols for an ergometer or an analog treadmill (see Chapter 7, "Editing Protocols") you must configure the slow and fast analog output properly to control the workload device. For ergometers, the analog output should be configured for workload; for analog treadmills, they should be configured for speed and grade.</p>
Fast Analog Output	<p>Determines the lead signals sent to the device. Options are:</p> <ul style="list-style-type: none"> • <i>Not Used</i> • <i>DC Heart Rate</i> • <i>Workload</i> • <i>Speed (x1)</i> • <i>Speed (x3)</i> • <i>Grade</i> • <i>Not used</i> • <i>I</i> • <i>II</i> • <i>V1-V6</i>
Blood Pressure	<p>Determines how the blood pressure will be entered into the system. Options are:</p> <ul style="list-style-type: none"> • <i>Manual</i> • <i>Ergoline Ergometer</i> • <i>Suntech</i> • <i>Nipon-Colin</i> <p>NOTE: If using the Sunteck blood pressure device, select the Ergoline emulation mode on the device. Refer to the Sunteck's operators manual for details.</p>

Inputs/Outputs (cont'd.)

Field	Description
TTL Output	Determines how the TTL output will be used. Options are: <ul style="list-style-type: none"> • Not Used • QRS Detect • BP Prompt NOTE: If selecting any of the external blood pressure devices, the TTL output must be configured to provide a QRS Trigger that meets the specifications of the blood pressure device. (See the blood pressure device operators manual for TTL trigger specifications.)
Polarity	Determines the polarity of the TTL Output. Options are: <ul style="list-style-type: none"> • Positive • Negative
Width	Defines the width of the TTL Output signal in milliseconds. Enter a value from 4 to 48.
Delay	Defines the delay in milliseconds for the TTL Output QRS detector signal. Enter a value from 0 to 100.
QRS Beep	Determines whether the system beeps for each QRS complex. Select On to enable the beep.

Hi-Res

To configure the settings for the **Hi-Res** option, select **System Setup > Hi-Res** and complete the fields described in the following table.

Hi-Res Settings

Field	Description
Analysis Filter	Determines which analysis filter to use. Options are: <ul style="list-style-type: none"> • 25-250Hz • 40-250Hz • 80-250Hz
Averaging Target	Selects the item to use for averaging the Hi-Res results. Options are: <ul style="list-style-type: none"> • Beat Count • Noise Level
Target Beat Count	Determines the target beat if Beat Count is selected as the Averaging Target . Enter the target number of beats per minutes.
Target Noise Level	Determines the target noise level if Noise Level is selected as the Averaging Target . Enter the target noise level in microVolts.

Hi-Res Settings (cont'd.)

Field	Description
Correlation Threshold	Determines the correlation threshold. Options are: <ul style="list-style-type: none"> • Medium • High • Very High • Ultra High
Template Format	Determines how many copies of this report print for the Hi-Res function. Enter a value from 0 to 10. If you enter 0, the report will not print.
Standard Format	Determines how many copies of this report print for the Hi-Res function. Enter a value from 0 to 10. If you enter 0, the report will not print.
Expanded Format	Determines how many copies of this report print for the Hi-Res function. Enter a value from 0 to 10. If you enter 0, the report will not print.
Overlapped Format	Determines how many copies of this report print for the Hi-Res function. Enter a value from 0 to 10. If you enter 0, the report will not print.
Prompt	Allows you to define two custom patient questions when entering patient data for the Hi-Res test.
Type	Determines the type of response allowed for each custom patient question. Options are: <ul style="list-style-type: none"> • Numbers and Letters • Numbers only • Yes or No

Setting Up a Card Reader

This section describes two methods for configuring the magnetic card reader:

- Automatic Configuration
- Manual Configuration

NOTE:

When configured for a card reader, the system will prompt you to slide the patient card when you select Patient Information. If no patient card is available, press **esc** to enter the patient information manually.

Automatic Configuration

Use the following procedure to automatically configure your magnetic card reader.

1. Obtain a configuration card.
For information on creating magnetic patient ID cards, refer to [Appendix E, "Creating Bar Codes and Magnetic Cards"](#).
2. With the card reader properly mounted, connect to port A on the back of the system.
3. From the **Main Menu**, select **System Setup > Basic System > Input Method Select > Patient Data Input Device > Card Reader > Return**.
4. When the **Manual Card Reader Configuration** window opens, press **esc**.
5. When the **Basic System** menu opens, press **esc**.
6. Select **Save Setup > To System**.
7. Restart the device.
8. From the **Main Menu**, select **System Setup > Basic System > Input Method Select > Card Reader Configuration > Automatic > Return**.
The following message is displayed:
Slide the Configuration Card
9. Slide the configuration card through the card reader.
The **Manual Card Reader Configuration** window opens with the values filled in.
10. Press **esc** twice.
11. Select **Save Setup > To System**.

Manual Configuration

Use the following procedure to manually configure your magnetic card reader.

1. With the card reader properly mounted, connect to port A on the back of the system.
2. From the **Main Menu**, select **System Setup > Basic System > Input Method Select > Patient Data Input Device > Card Reader > Return**.
The **Manual Card Reader Configuration** window opens.
3. Enter the magnetic card code configuration information.
For information on creating magnetic patient ID cards, refer to [Appendix E, "Creating Bar Codes and Magnetic Cards"](#).
4. Press **esc** twice.
5. Select **Save Setup > To System**.

Setting Up a Bar Code Reader

This section describes two methods for configuring the bar code reader:

- Automatic Configuration
- Manual Configuration

NOTE:

When configured for a bar code reader, the system will prompt you to scan the patient ID bar code when you select Patient Information. If no bar code is available, press **esc** to enter the patient information manually.

Do not use the bar code reader for scanning the bar code that appears on the ECG printout: that bar code format is not supported by the bar code reader.

Automatic Configuration

Use the following procedure to automatically configure your bar code reader.

1. Obtain a configuration bar code.
For information on creating patient bar codes, refer to [Appendix E, "Creating Bar Codes and Magnetic Cards"](#).
2. Connect the bar code reader to port A on the back of the system.
3. From the **Main Menu**, select **System Setup > Basic System > Input Method Select > Patient Data Input Device > Bar Code Reader > Return**.
4. When the **Manual Bar Code Reader Configuration** window opens, press **esc**.
5. When the **Basic System** menu opens, press **esc**.
6. Select **Save Setup > To System**.
7. Restart the device.
8. From the **Main Menu**, select **System Setup > Basic System > Input Method Select > Bar Code Reader Configuration > Automatic > Return**.

The following message is displayed:

Scan the Configuration Bar Card

9. Scan the bar code.
The **Manual Bar Code Reader Configuration** window opens with the values filled in.
10. Press **esc** twice.
11. Select **Save Setup > To System**.

Manual Configuration

Use the following procedure to manually configure your bar code reader.

1. Connect the bar code reader to port A on the back of the system.
2. From the **Main Menu**, select **System Setup > Basic System > Input Method Select > Patient Data Input Device > Bar Code Reader > Return**.

The **Manual Bar Code Reader Configuration** window opens.

3. Enter the bar code configuration information.
For information on creating bar codes, refer to [Appendix E, "Creating Bar Codes and Magnetic Cards"](#).
4. Press **esc** twice.
5. Select **Save Setup > To System**.

Setting Up Master's Step Test

To configure the **Master's Step Test**, log on to the **System Setup** screen, select **Master's Step**, and complete the fields described in the following table.

NOTE:

This option is available only Japan.

Master's Step Setup

Field	Description
Number of Steps	Defines the default number of steps required by the Master's Step test if the patient's weight, sex, and age are not entered. If the patient's age weight, sex, and age are entered, the number of steps is automatically calculated. For more information, refer to Appendix D, "Master's Step Data" .
Test Type	Determines the test duration. Options are: <ul style="list-style-type: none"> • Single Sets the test for a 1.5 minute duration. • Double Sets the test for a 3 minute duration. • Triple Sets the test for a 4.5 minute duration.
Post J(ms)	Defines the location, in milliseconds, after the J point to determine the ST measurement.
Step Counter Display	Determines whether the system displays the number of steps taken or remaining. Options are: <ul style="list-style-type: none"> • Up Displays the number of steps taken so far. • Down Displays the number of steps remaining.
Sound Option	Sets the sound volume for the Master's Step Test . Select one of the following options: <ul style="list-style-type: none"> • 1 • 2 • 3 • Off

Master's Step Setup (cont'd.)

Field	Description
Continuous Recording	Determines whether the rhythm is printed continuously between post exercise ECGs.
Post Exercise ECG Time	Defines the time, in minutes, after the first post exercise ECG when an additional ECG should be taken. You can take up to nine ECGs. Set any undesired tests to 0.

Managing System Setup

This section describes how to do the following:

- Print System Setup
- Save System Setup
- Restore System Setup

Printing System Setup

To print your system settings for future reference, select **System Setup > Print Setup**.

Place the printout in a secure location in case you need to manually restore the settings at a later date.

Saving System Setup

To save the changes you make to your system settings, select **System Setup > Save Setup**. You can choose to save the settings to local memory or to an SD card.

After saving your changes to local memory, you should also save the settings to an SD card for use in restoring your settings at a later date. You can also use a saved configuration to quickly configure subsequent systems.

NOTE:

Saving the system setup to an SD card does NOT save your **Critical Values** configuration. You must manually save the **Critical Values** configuration. Refer to "Saving Critical Values to SD Card" on page 145 for more information.

Restoring System Setup

Restore Setup allows you to revert your settings. You can use this option to return to the default factory settings or to restore custom settings that were saved to an SD card. If using an SD card, you can also use this feature to quickly configure other MAC systems.

To restore your system settings, do the following:

1. From the Main Menu, select **System Setup > Restore Setup**.
2. Do one of the following:
 - To restore the default settings, select **To Original Factory Settings**.
 - To restore your custom settings, select **From SD Card**.

An SD card with the system settings must be inserted into the device's card slot.

- To cancel the restore, select ***Do Not Restore Setup***.



Maintenance

Regular maintenance, irrespective of usage, is essential to ensure that the equipment will be functional when required. For the MAC system, regular maintenance includes the following:

- Equipment Inspection and Cleaning
- Paper Maintenance
- Battery Maintenance
- Leadwire Adapter Replacement

For the maintenance procedures for your peripheral equipment, refer to the documentation provided with that equipment.

WARNING:

MAINTENANCE — Failure on the part of all responsible individuals, hospitals, or institutions employing the use of this device to implement the recommended maintenance schedule may cause equipment failure and possible health hazards. The manufacturer does not in any manner, assume the responsibility for performing the recommended maintenance schedule, unless an Equipment Maintenance Agreement exists. The sole responsibility rests with the individuals, hospitals, or institutions utilizing the device.

Inspecting and Cleaning the MAC System

When inspecting and cleaning your system, take the following precautions:

- Turn off the system.
- Do NOT immerse any part of the equipment in liquid.
- Do NOT use organic solvents, ammonia based solutions, or abrasive cleaning agents. These may damage the equipment surfaces.

Inspecting the MAC System

Perform a visual inspection of all equipment and peripheral devices daily. If you notice any items that need repair, do not use the equipment until an authorized service person has completed the repairs.

- Check the case and display screen for cracks or other damage.
- Inspect all plugs, cords, cables, and connectors for fraying or other damage.

- Verify that all cords and connectors are securely seated.
- Inspect keys and controls for proper operation:
 - Toggle keys should not stick in one position.
 - Knobs should rotate fully in both directions.

Cleaning and Disinfecting Exterior Surfaces

Clean and disinfect the exterior surfaces of all equipment and peripheral devices monthly, or more frequently if needed.

Cleaning and Disinfecting the Surfaces

Proper cleaning and disinfecting prolongs the life of the product. Failure to use the proper cleaning solutions or to follow proper procedures can result in the following:

- Damage or corrosion
- Product discoloration
- Metal part corrosion
- Unit malfunction
- Voided warranty

Use the following procedure to clean the equipment's exterior surfaces. Be sure to observe all cautions when cleaning the device.

1. To clean, wipe with a lightly moistened cloth.

Use a mild soap and water solution to moisten the cloth.

Do NOT use any of the following cleaning products, or products that contain the same active ingredients and solutions, which are known to cause the problems previously listed:

- Sani-Cloth® Wipes
- Ascepti® Wipes
- HB Quat®
- Clorox® Wipes (they do not contain bleach)
- Over-the-counter detergents (such as Fantastic®, Tilex®, and so on)

2. To disinfect, wipe with a soft, lint-free cloth moistened with an appropriate disinfectant.

Use the following solutions, as recommended in the APIC Guidelines for Selection and Use of Disinfectants (1996):

- Sodium hypochlorite (5.2% household bleach) minimum 1:500 dilution (minimum 100 ppm free chlorine) and maximum 1:10 dilution.
- Any sodium hypochlorite wipe product that meets the previous guidelines can be used.

3. Dry with a clean cloth or paper towel.

Cautions

- Follow the cleaning instructions exactly.
- Wring excess disinfectant from wipe before using.
- Never immerse the device, cables, or leadwires in any liquid, as this may corrode metal contacts and affect signal quality.
- Do not allow fluid to pool around connection pins. If this happens, blot dry with a soft, lint-free cloth.
- Never use conductive solutions or solutions that contain chlorides, wax, or wax compounds to clean the device, cables, or leadwires.
- Never use solutions or products that contain any type of Ammonium Chloride such as, but not limited to:
 - Dimethyl Benzyl Ammonium Chloride
 - Quaternary Ammonium Chloride solutions
 - Abrasive cleaners or solvents of any kind
 - Acetone
 - Ketone
 - Betadine
 - Alcohol-based cleaning agents
 - Sodium salts
- Never autoclave or steam clean the device, cables, or leadwires.
- Do not use until thoroughly dry.

Cleaning, Disinfecting, and Storing ECG Cables and Leadwires

In addition to keeping the MAC system clean and in good repair, it is important to keep the leadwires clean and disinfected. This section provides instructions for cleaning, disinfecting, and storing ECG cables and leadwires to extend their life and protect patients.

NOTE:

This information applies to the Multi-Link cable and leadwires. For systems with the optional KISS system, see the KISS operator's manual for cleaning and disinfecting information.

Cleaning and Disinfecting Leadwires

Proper cleaning and disinfecting prolongs the life of cables and leadwires. Failure to use the proper cleaning solutions or to follow proper procedures can result in the following:

- Damage or corrosion
- Diminished signal quality
- Product discoloration
- Metal part corrosion
- Brittle wires and connectors
- Reduced cables and leadwires life



warranty

Use the following procedure to clean and disinfect the cables and leadwires.

1. Remove cables and leadwires from the device or system before cleaning.
2. Use care in cleaning leadwires to prevent pulling the long wires from the connector ends. Metal connections can be pulled away from the connectors.
3. To clean, wipe with a lightly moistened cloth.

Use a mild soap and water solution to moisten the cloth.

Do NOT use any of the following cleaning products, or products that contain the same active ingredients and solutions, which are known to cause the problems previously listed:

- Sani-Cloth® Wipes
- Ascepti® Wipes
- HB Quat®
- Clorox® Wipes (they do not contain bleach)
- Over-the-counter detergents (such as Fantastic®, Tilex®, and so on)

4. To disinfect, wipe with a soft, lint-free cloth moistened with an appropriate disinfectant.

Use the following solutions, as recommended in the APIC Guidelines for Selection and Use of Disinfectants (1996):

- Sodium hypochlorite (5.2% household bleach) minimum 1:500 dilution (minimum 100 ppm free chlorine) and maximum 1:10 dilution.
- Any sodium hypochlorite wipe product that meets the previous guidelines can be used.

5. Observe the following guidelines when cleaning and disinfecting cables and leadwires.
 - Do NOT immerse either end of a cable or leadwire connector. Immersing or “soaking” the connector ends may corrode metal contact ends and affect signal quality.
 - Do NOT let fluid “pool” around connection pins. If this happens, blot dry with a soft, lint-free cloth.

6. Dry the cable and leadwires thoroughly with a dry lint-free cloth and let air dry for at least 30 minutes.

DO NOT use excessive drying techniques, such as oven, forced heat, or sun drying.

NOTE:

Drying times may vary based on the environmental conditions.

Cautions

- Follow the cleaning instructions exactly.
- Wring excess disinfectant from wipe before using.

- Never immerse the device, cables, or leadwires in any liquid, as this may corrode metal contacts and affect signal quality.
- Do not allow fluid to pool around connection pins. If this happens, blot dry with a soft, lint-free cloth.
- Never use conductive solutions or solutions that contain chlorides, wax, or wax compounds to clean the device, cables, or leadwires.
- Never use solutions or products that contain any type of Ammonium Chloride such as, but not limited to:
 - Dimethyl Benzyl Ammonium Chloride
 - Quaternary Ammonium Chloride solutions
 - Abrasive cleaners or solvents of any kind
 - Acetone
 - Ketone
 - Betadine
 - Alcohol-based cleaning agents
 - Sodium salts
- Never autoclave or steam clean the device, cables, or leadwires.
- Do not use until thoroughly dry.

Storage

Store cables and leadwires by hanging them vertically in a dry, well-ventilated area. Do NOT coil leadwires or cables around the device.

Cleaning, Disinfecting, and Storing Handheld Devices

In addition to keeping the MAC system, leadwires, and cables clean and in good repair, it is important to keep the associated acquisition modules clean and disinfected as well. This section provides instructions for cleaning, disinfecting, and storing the acquisition modules to extend their life and protect patients.

Cleaning and Disinfecting Acquisition Modules

Proper cleaning and disinfecting prolongs the life of acquisition devices. Failure to use the proper cleaning solutions or to follow proper procedures can result in the following:

- Appearance of waveforms when not connected to a patient, resulting in false alarms instead of lead failure alarms
- Brittle and cracked device case
- Melting, dulling, or distortion of the case
- Total device failure, requiring replacement
- Unit malfunction
- Voided warranty

Use the following procedure to clean and disinfect the cables and leadwires.

1. Remove cables, leadwires, and batteries from the device before cleaning.

Make sure to firmly close the battery door after removing the batteries.

2. To clean, wipe with a lightly moistened cloth.

Use a mild soap and water solution to moisten the cloth.

Do NOT use any of the following cleaning products, or products that contain the same active ingredients and solutions, which are known to cause the problems previously listed:

- Sani-Cloth® Wipes
- Ascepti® Wipes
- HB Quat®
- Clorox® Wipes (they do not contain bleach)
- Over-the-counter detergents (such as Fantastic®, Tilex®, and so on)

3. To disinfect, wipe with a soft, lint-free cloth moistened with an appropriate disinfectant.

Use the following solutions, as recommended in the APIC Guidelines for Selection and Use of Disinfectants (1996):

- Sodium hypochlorite (5.2% household bleach) minimum 1:500 dilution (minimum 100 ppm free chlorine) and maximum 1:10 dilution.
- Any sodium hypochlorite wipe product that meets the previous guidelines can be used.

4. Allow the cleaning solution/disinfectant to remain on the device for a minimum of one minute, or per hospital guidelines.

5. Wipe off the cleaning solution/disinfectant with a clean, moistened cloth.

6. Dry thoroughly with a dry, lint-free cloth and let air dry for a minimum of 30 minutes before use.

DO NOT use excessive drying techniques, such as oven, forced heat, or sun drying.

NOTE:

Drying times may vary based on the environmental conditions.

Cautions

- Follow the cleaning instructions exactly.
- Wring excess disinfectant from wipe before using.
- Never immerse the device, cables, or leadwires in any liquid, as this may corrode metal contacts and affect signal quality.
- Do not allow fluid to pool around connection pins. If this happens, blot dry with a soft, lint-free cloth.
- Never use conductive solutions or solutions that contain chlorides, wax, or wax compounds to clean the device, cables, or leadwires.

To Purchase, Visit  www.avobus.com 1-800-674-2855 or call your local distributor for more information. Do not use any type of Ammonium Chloride such



thyl Benzyl Ammonium Chloride

- Quaternary Ammonium Chloride solutions
- Abrasive cleaners or solvents of any kind
- Acetone
- Ketone
- Betadine
- Alcohol-based cleaning agents
- Sodium salts
- Never autoclave or steam clean the device, cables, or leadwires.
- Do not use until thoroughly dry.

Storage

Use the following guidelines when storing acquisition modules:

- Always remove the batteries when the device is not in use, even for short periods of time.
- Store in a dry, well-ventilated area.
- Hang the device, using a holder if available.
- If leadwires are attached, they should hang straight.
- Do not coil leadwires or cables around the device.

Battery Compartment Cleaning

NOTE:

This procedure applies only for frequency hopping telemetry transceivers. It should not be used for other devices.

Under normal operation, the battery compartment should not require cleaning. If the battery compartment should require cleaning, use the following instructions.

CAUTION:

DEVICE MALFUNCTION — Cleaning the battery compartment in a manner other than that described in the following procedure may cause the unit to malfunction and void the warranty.

The battery compartment is not waterproof. Make certain fluids do not enter the electronics through the air holes in the battery compartment floor.

1. Remove the battery from the battery compartment.
2. Clean the device with a gauze pad or cloth lightly moistened with one of the following agents:
 - Water
 - Soap

3. Use a cloth lightly moistened with distilled water to rinse away the cleaning solution. Make certain that moisture does not enter the electronics area below the battery compartment floor.
4. Dry thoroughly with a lint-free cloth and allow the battery compartment to air dry completely prior to closing the compartment door.

Paper Maintenance

Proper paper maintenance ensures optimum ECG printouts. Paper maintenance includes:

- Setting the correct paper size
- Loading the paper

Setting the Correct Paper Size

The MAC system can accommodate standard (US Letter) and A4 fanfold thermal ECG paper. To ensure that the paper feeds correctly, you must adjust the paper guide

1. Open the MAC writer drawer.

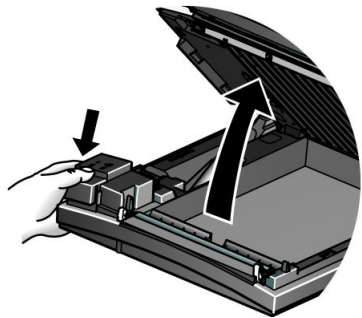

2. To set the tray for A4 paper, slide the paper guide toward the rear of the device.

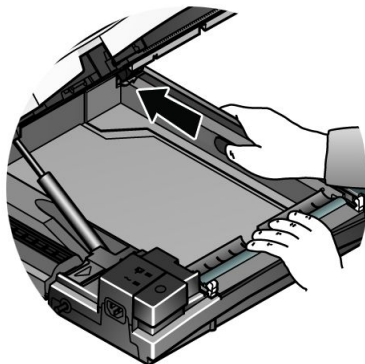

3. To set the tray for standard (US Letter) paper, slide the guide toward the front of the device.

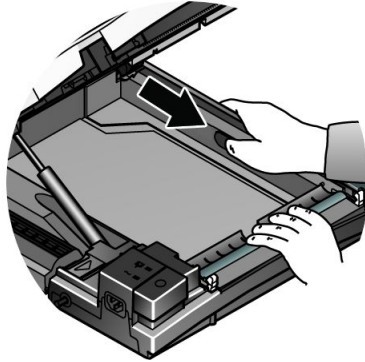

4. You are now ready to load your paper.

Loading the Paper

Use the following instructions to load paper into the MAC system. Refer to the following illustration.

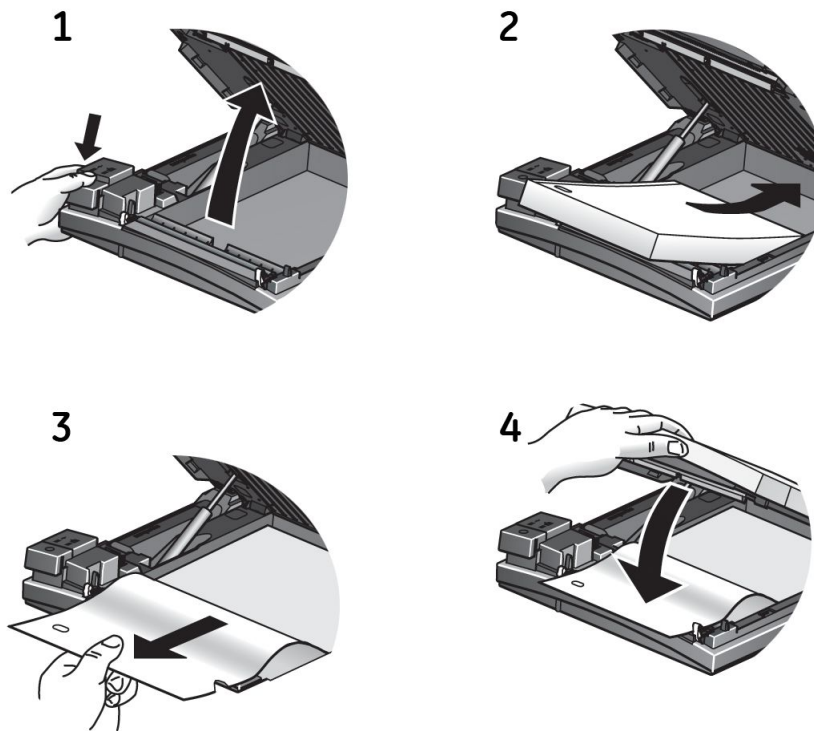

1. Open the writer drawer.
2. Place the pad of paper with the holes on the left.

To Purchase, Visit Avobus.com 1-800-647-2055

the writer drawer securely.



Battery Maintenance

Proper battery maintenance prolongs the battery life and ensures that the MAC system will operate when needed. Proper maintenance consists of the following:

- Charging the battery
- Conditioning the battery
- Replacing the battery

Charging the Battery

A fully charged battery ensures that the MAC system will operate without being connected to an AC outlet. The MAC system's battery should be charged at the following times:

- Before initial use
- Between acquisitions
- When the battery is low
- When the battery is completely discharged

To determine when the battery is low, use the battery gauge icon that appears in the upper right corner of the system screen.

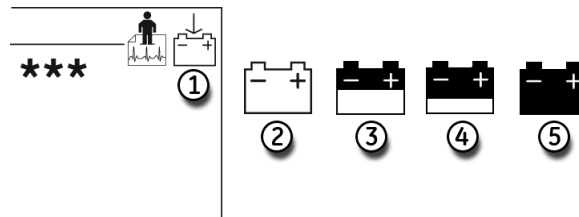

Item	Description
1	Battery gauge icon position.
2	Battery fully charged.
3	Battery 1/2 charged.
4	Battery 1/4 charged.
5	Battery fully discharged.

NOTE:

The system may run for a long time after the fully-discharged icon appears. When the battery is fully discharged, the system will power off. To operate your system at that time, you must connect the system to an AC wall outlet.

Use the following procedure to charge the battery:

1. Power off the system.
2. Connect the system to an AC wall outlet.

To indicate the battery is charging, the amber battery light glows (1) and the charging battery icon is displayed on the screen (2).

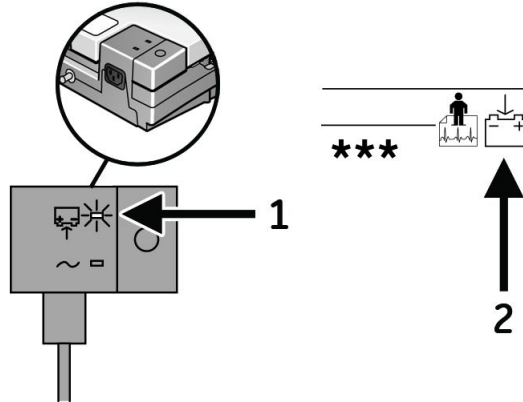

3. Charge the system for 4–5 hours or until the battery gauge icon indicates a full charge.

NOTE:

If the battery is fully charged or exceeds safe charging temperature, the system will not charge the battery.

Conditioning the Battery

In addition to normal system use, periodic deep discharge cycles may be required to ensure consistent battery performance. A deep discharge cycle occurs when the battery is discharged until the system shuts down and then recharged until it is full.

GE Healthcare recommends one deep discharge cycle once every three months, but does not recommend over-exercising the battery with multiple deep discharge cycles.

Replacing the Battery

No matter how well you maintain your battery, you will eventually need to replace it. Refer to the following illustration for instructions on how to replace the battery.

1



2

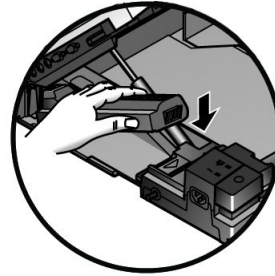

3

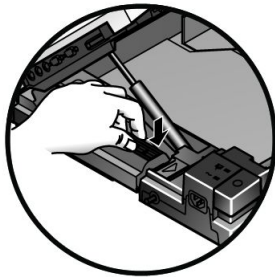

WARNING:

BATTERY PACK DISPOSAL — Do NOT dispose of the battery pack by fire or burning.
Follow local environmental guidelines concerning disposal and recycling.

WARNING:



CHEMICAL BURN — If battery fluid contacts your skin, eyes, or clothing,
immediately wash the area with clean water and see a doctor.

Replacing Leadwire Adapters

The following diagram shows how to replace the acquisition leadwire adapters:

To Purchase, Visit

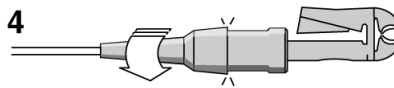
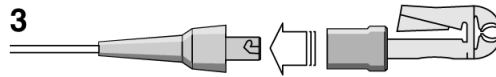
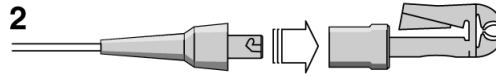
1-800-674-2155
Avobus.com





Troubleshooting

The following sections identify some of the more common problems with the MAC system and list their potential causes and solutions. If this information cannot resolve your issue, contact GE Healthcare Technical Support.

General Troubleshooting Guidelines

If the system is not working properly, save time troubleshooting by asking these basic questions:

- Is the unit turned on?
- Have there been any changes in the use, location, or environment of the equipment that could cause the failure?
- Has the equipment's hardware or software been modified?
- Is operator error the cause of the problem? Try to repeat the scenario exactly and compare that to the proper operation of the equipment described in the manual.
- Is the battery installed?
- When connected to an AC wall outlet, does the green AC power light glow?
- Is the writer door closed?

Visual Inspection

A thorough visual inspection of the equipment can save time. Items such as disconnected cables or missing hardware can frequently cause symptoms and equipment failures that may appear to be unrelated and difficult to track. For additional information, see [Appendix A, "Maintenance"](#).

Performance Problems

This section describes some of the more common performance problems with the MAC system. Typically, these result from faulty peripherals, configuration issues, or operator error.

Unacceptable Noise Levels

If the acquired ECG data displays unacceptable noise levels, do the following:

- Verify proper electrode placement.

Slipped or misplaced electrodes can result in faulty readings. Refer to [“Preparing the Patient's Skin” on page 54](#).

- Verify proper electrode application.
Perspiration, excessive hair, lotions, and dead skin cells must be removed from the electrode site. Refer to [“Electrode Placement” on page 55](#).
- Check for defective or expired electrodes.
Verify the electrodes have not exceeded their shelf life.
- Check for defective, broken, or disconnected leadwires.
Replace or reconnect leadwires as necessary.
- Check the patient's position.
The patient should remain motionless during the acquisition of a resting ECG.

ACI-TIPI Report Does Not Print

If the ACI-TIPI report does not print when expected, do the following:

- Verify ACI-TIPI is enabled.
Refer to [“Setting Up ACI-TIPI Interpretation” on page 118](#).
- Verify the selected report format includes **Interpretation**.
Reports *without interpretation* will not include ACI-TIPI information.
- Verify the ACI-TIPI information was entered for the patient.
ACI-TIPI requires that age range, gender, and chest/arm pain complaints be entered.
- Verify the patient is older than 16.
ACI-TIPI does not apply for pediatric patients.
- Verify the original ECG was acquired with an electrocardiograph with the ACI-TIPI option enabled.
ACI-TIPI information must be gathered when the ECG was acquired.

For more information, refer to [“Setting Up ACI-TIPI Interpretation” on page 118](#).

External Device Does Not Record BP Readings

If an external device is not automatically recording blood pressure as expected, do the following:

- Check the blood pressure device setup.
- Check the serial and TTL cables to make sure they are seated correctly.
- Check the TTL trigger.

For more information, refer to [“Inputs and Outputs” on page 153](#).

Treadmill/Ergometer Does Not Move



If the exercise equipment is not moving in response to the test protocol, do the following:

- Check the protocol.
Verify it is set up to control the equipment. Refer to [Chapter 7, “Editing Protocols”](#).
- Check the cables.
Verify that the device is connected to the correct port, that the cable is seated securely, and that the cable is not frayed or damaged.
- Check the system's input/output settings.
Refer to [“Inputs and Outputs” on page 153](#).

- Check the Emergency Stop switch on the device. Verify it is not depressed.
- Check the device settings. Verify that it does not retain settings from the previous patient.

System Errors

The following errors may occur while you are operating this system. You may be required to perform some action. If you perform the recommended actions and the condition still remains, contact authorized service personnel.

Problem	Cause	Solution
The following icon appears: 	No battery is installed in the system.	Install a battery and connect the system to an AC wall outlet to charge the battery. Refer to "Battery Maintenance" on page 172 .
The following icon flashes: 	The battery charge is low.	Connect the system to an AC wall outlet to charge the battery. Refer to "Battery Maintenance" on page 172 .
The following icon appears: 	The writer door is open.	Close the writer door. Refer to "Paper Maintenance" on page 170
The system does not power up when operating from battery.	The battery is fully discharged.	Connect the system to an AC wall outlet to charge the battery. Refer to "Battery Maintenance" on page 172 .
The system shuts down when operating from battery.	Battery is discharged.	Connect the system to an AC wall outlet to charge the battery. Refer to "Battery Maintenance" on page 172 .
	The Automatic Shutdown feature is enabled.	Power up the unit. Adjust the Automatic Shutdown settings if necessary. Refer to Chapter 14, "System Setup" .
The lead disconnected message appears.	Electrode(s) disconnected.	Reconnect the electrode(s). Refer to Chapter 3, "Preparing the Patient" .
The following message appears: MODEM ERROR. The remote device is not responding. Would you like to retry?	Modem is not connected. (If using the wireless option, the client bridge is not connected or the device is out of range.)	Connect the modem to a telephone line and retry, or move back into range.
	(Wireless option only) The system is not within range of an access point.	Relocate the system to within range of an access point and retry transmission.
	(Ethernet option only) Bad LAN connection.	Verify that the LAN cable is connected to the LAN port and the Link LED (Green) lights up and Activity LED (Yellow) blinks.

Troubleshooting

Problem	Cause	Solution
Cannot use the system because Device Password does not work.	Device Password has been changed or has not been adequately communicated to the staff.	Contact your administrator for the Device Password.
You are prompted to format to recover the file system.	The internal storage has been corrupted.	Format the internal storage to restore the file system. NOTE: System recovery from internal storage corruption will destroy all ECG records in the system's internal memory.



Report Formats

The MAC system provides several report formats to provide the information you need to analyze and evaluate the patient's ECG. The following sections describe the available formats so you can choose the correct report for your needs.

Numeric Reports

Several reports use numeric titles that describe the way in which the data is presented. For example, the report **4 by 2.5s + 1 rhythm ld** presents the following information:

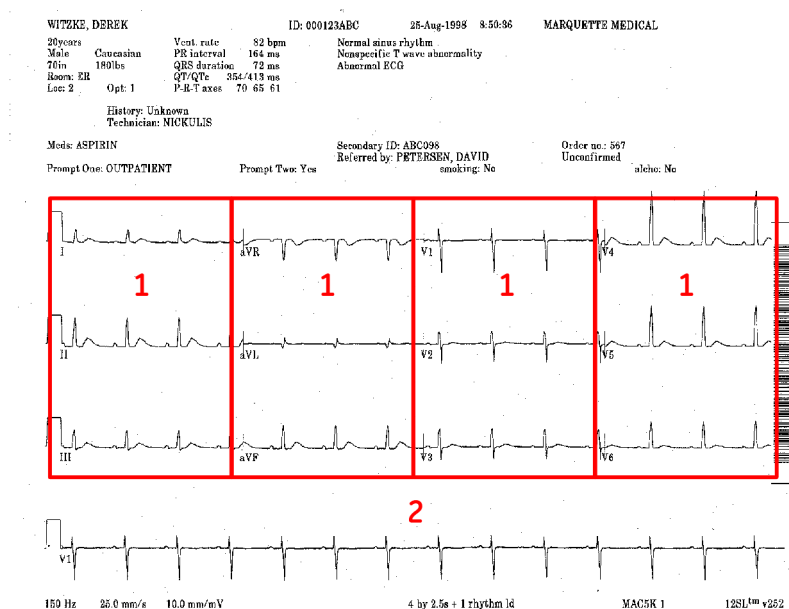

- 1 Four columns of data containing 3 leads with 2.5 seconds of data in each lead (**4 by 2.5s**).
- 2 One 10-second rhythm lead (**1 rhythm ld**).

The following numeric reports are available.

- **2 by 5**
- **2.5s @ 50 mm/s (writer speed)**
- **2 by 5s + 1 rhythm lead**

- 2 by 10s
- 3 by 5 @ 50mm/s
- 3 by 10s
- 4 by 2.5s
- 4 by 2.5s + 1 rhythm lead
- 4 by 2.5s + 3 rhythm leads
- 4 by 10s
- 5 by 2s
- 5 by 2s + 1 rhythm lead
- 5 by 2s + 3 rhythm leads
- 5 by 10s

Additional Reports

The following additional report formats are available.

Report	Description
12 Rhythm Leads	10 seconds of 12-lead rhythm.
Autorhythm	10 seconds of 3, 6, or 12 leads of rhythm.
CGR	One median complex for each of the 12 leads combined with 10 seconds of 3-lead rhythm.
Expanded Median	Doubles the speed and gain of the median complex.
Linked Median	A 4 x 2.5 with 1 rhythm lead format. The rhythm lead printed across the bottom of the report is the first lead of the 'Swedish format rhythm leads' group that is configured in Exercise Setups (Report Leads).
Medians and Rhythm	A median complex for each of the standard 12 leads is displayed in the upper portion of this report. Below the medians are three rhythm strips. These rhythm leads are the first three leads of the 'Swedish format rhythm leads' group that is configured in Exercise Setups (Report Leads).
6 Lead Comparative Medians and Rhythm	The baseline and current medians are compared side-by-side and followed by real-time waveforms. The 6 leads used by this report are the 'Swedish format rhythm leads' group that is configured in Exercise Setups (Report Leads).
12 Lead Comparative Medians and Rhythm	A one-page report for which the baseline and current medians are compared side-by-side and followed by 2.5 seconds of real-time rhythm for the standard 12 leads. ST level and ST slope are reported for each lead.
Hi-Res or PHi-Res Signal Averaged Template	Hi-Res or PHi-Res Signal Averaged Template
Hi-Res or PHi-Res Signal Averaged Standard	Vector magnitudes of X,Y,Z.
Hi-Res or PHi-Res Signal Averaged Expanded	400mm/s of expanded X,Y,Z medians and a RMS voltage function/VM plot.

Report	Description
ACI-TIPI	The analysis of the acquired ECG data appears at the top of the report.
Hi-Res or PHi-Res Signal Overlapped	X,Y,Z data at two different amplitudes.
RMR	One median complex for each of the 12 leads combined with 10 seconds of 3-lead rhythm.
Swedish Format 1	One median complex for each of the 12 leads at writer speed of 50mm/s combined with 5 seconds of 6-lead rhythm at half writer speed. Text is on the bottom of the page.
Swedish Format 2	5 seconds for each of the 12 leads at writer speed 50mm/s. Text is on the top of the page.
2 by 5s Simultaneous	<p>Displays and prints ECG data in a 2 x 5 second simultaneous format. This report format allows you to enable Auto Gain and/or Auto Shift features.</p> <p>NOTE:</p> <p>The Auto Shift feature automatically shifts the waveforms vertically to avoid (or minimize) waveform overlap between rows. If enabled, this feature affects only the printed 2x5-second report.</p> <p>The Auto Gain feature adjusts the gain to minimize waveform overlap. Depending on the amount of overlap, the Auto Gain may be applied to all leads or only the chest leads. If enabled, this feature affects the printed 2x5-second report.</p> <p>If both Auto Shift and Auto Gain are selected, the 2x5-second printed report will be a 2- or a 3-page report.</p> <ul style="list-style-type: none"> • The first page will be in the 2x5 format with the default system gain and with Auto Shift applied. • In most cases, if waveforms overlap on the first page, the second page will be in the 2x5 format with Auto Shift and Auto Gain applied. This page is only printed if the first page had waveform overlap. • The third page will be the 10-second rhythm strip for the first extra lead defined in the resting ECG lead setup with the default gain. <p>Select Yes for Auto Gain and/or Auto Shift to enable these features.</p>
Pharma 4 by 2.5s + 2 Rhythm Leads	Displays and prints clinical trial data in a 4 x 2.5s format with two rhythm leads.
Vector Loops	Sagittal, horizontal, and frontal plane vectorgrams. Marks on sample X,Y,Z complexes identify P onset and offset, Q onset and offset, and T onset.

In-Test Reports

The following formats are available for printing during the test.

Report	Description
12 or 15-Lead Report	Based on Exercise report setups, a variety of 12 or 15 Lead report formats will print without ECG analysis when the 12 ld key is pressed or when 12/15 lead reports are configured in the protocol.
5 Second Rhythm Report	This report can be chosen from the Edit Protocol application to print at certain points during the test.
Rhythm Report	A continuous, real-time recording of raw data - 3, 6, 12 leads. Leads for rhythm report correspond to leads on the screen.
Arrhythmia Report	Automatic documentation of arrhythmias with 2.5 seconds of raw data prior to the ectopic beat. Leads of arrhythmia report correspond to leads on the screen.
Recall Report	A delayed recording of raw data 10 seconds in duration. Leads of recall report correspond to leads on the screen.
Median Report	Based on exercise setups, a Linked Median, Medians & Rhythms, 6 or 12 Lead Comparative Medians & Rhythm report will print. See "Additional Reports" on page 182 for a description of these formats.

Exercise Final Reports

The following formats are available for the final exercise report.

Report	Description
Summary Report	One page overview of test with Resting and Max ST or peak median morphologies. For Maximal ST Depression, report only prints when a minimum of -.5 mm of ST depression occurs in one of the following leads: I, II, III, aVF, V2-V6. (V1, aVR, aVL excluded. For elevation, - aVR is excluded.)
Tabular Report	Tabular summary of test by stage including time, speed, grade, workload, MET level, heart rate, blood pressure, RPP, and comments.
Selected Medians Report	Records median morphologies at Baseline, Maximum ST Depression, Peak Exercise, and Test End for 12 leads. For Maximum ST medians, the column only prints when a minimum of -.5 mm of ST depression occurs in one of the following leads: I, II, III, aVF, V2-V6. (V1, aVR, aVL excluded. For elevation, - aVR is excluded.)
Trends and Medians	Records a plot of the heart rate and blood pressure against time. Next to these trend graphs are channels of stored median data from the various stages of an exercise test.
Median Report	Records median morphologies for 3, 6 or 12 leads. The 3 and 6 lead reports are configured using the 'Swedish format rhythm leads' of the Exercise Setups (Report Leads). The 12-lead report uses the standard 12-lead set. The median storage intervals (also referred to as sample cardiac cycles) can be configured using the Median (First and Repeat) column of the Protocol Editor.
Trend Reports	Records plots of PVCs, heart rate, and blood pressure. Also produces a trend report of ST level and slope vs. time. The 3-lead trend report will use the first three leads of the 'Swedish format rhythm leads'.
ST/HR Loops Report	A two-dimensional representation of ST Level vs. Heart Rate.
ST/HR Slope Report	Records linear regression of heart rate-adjusted slope for all leads, plus median morphology of the lead with the highest slope.

Exercise Report Codes

The following report codes are printed in the lower left corner of the exercise reports.

Code	Description
A+	Auto Arrhythmia Reporting is ON.
A-	Auto Arrhythmia Reporting is OFF.
H+	Stag Hold is ON.
H-	Stag Hold is OFF.
S+	Cubic Spline is ON.
S-	Cubic Spline is OFF.
50	50Hz AC filter is ON.
60	60Hz AC filter is ON.
HR	Binary encoded format for heart rate leads.



Master's Step Data

The following sections provide the information you need to run a **Master's Step** stress test.

NOTE:

The **Master's Step** is an option and is available only in Japan.

Master's Step Table

The following table identifies the number of steps to set according to the patient's age, sex, and weight.

Weight (kg)	Sex	Age (Years)														
		5-9	10-14	15-19	20-24	25-29	30-34	35-39	40-44	45-49	50-54	55-59	60-64	65-69	70-74	75-79
18-22	Male	35	36													
	Female	35	35	33												
22-26	Male	33	35	32												
	Female	33	33	32												
27-31	Male	31	33	31												
	Female	31	32	30												
32-35	Male	28	32	30												
	Female	28	30	29												
36-40	Male	26	30	29	29	29	28	27	27	26	25	25	24	23	23	22
	Female	26	28	28	28	28	27	26	24	23	22	21	21	20	19	18
41-44	Male	24	29	28	28	28	27	27	26	25	24	23	22	22	21	22
	Female	24	27	26	27	26	25	24	23	22	21	20	19	18	18	17
45-49	Male	22	27	27	28	28	27	26	25	25	24	23	22	22	21	20
	Female	22	25	25	26	26	25	24	23	22	21	20	19	18	18	17
50-53	Male	20	26	26	27	27	26	25	25	24	23	22	22	22	21	20
	Female	20	23	23	25	25	24	23	22	21	20	19	18	18	17	16
54-58	Male	18	24	25	26	27	26	25	24	23	22	22	21	21	20	19
	Female	18	22	22	24	24	23	22	21	30	19	18	18	17	16	15
59-63	Male	16	23	24	25	26	25	24	23	23	22	21	20	20	19	18
	Female	16	20	20	23	23	22	21	20	19	19	18	17	16	15	15
64-67	Male		21	23	24	25	24	24	23	22	21	20	20	19	18	18
	Female		18	19	22	22	21	20	19	19	18	17	16	15	15	14
68-72	Male		20	22	24	25	24	23	22	21	20	20	19	18	18	17
	Female		17	17	21	20	20	19	19	18	17	16	16	15	14	13

Weight (kg)	Sex	Age (Years)														
		5-9	10-14	15-19	20-24	25-29	30-34	35-39	40-44	45-49	50-54	55-59	60-64	65-69	70-74	75-79
73-76	Male		18	21	23	24	23	22	22	21	20	19	18	18	17	17
	Female		15	16	20	19	19	18	18	17	16	16	15	14	13	12
77-81	Male			20	22	23	23	22	21	20	19	18	18	17	17	16
	Female		13	14	19	18	18	17	17	16	16	15	14	13	13	12
82-85	Male			19	21	23	22	21	20	19	19	18	17	16	16	15
	Female			13	18	17	17	17	16	16	15	14	14	13	12	11
86-90	Male			18	29	22	21	21	29	18	17	17	16	15	15	14
	Female			12	17	16	16	16	15	15	14	13	13	12	12	11
91-93	Male				19	21	21	20	19	18	17	16	16	15	14	14
	Female				16	15	15	15	14	14	13	13	12	11	11	10
94-99	Male				18	21	20	19	18	17	17	16	15	14	14	13
	Female				15	14	14	14	13	13	13	12	11	11	11	10
100-104	Male				17	20	20	19	18	17	16	15	14	13	13	12
	Female				14	13	13	13	13	12	12	11	11	10	10	09

ST  1-800-674-2155 avobs.com



Change of any ST-T change is assessed by classifying ST-T into three assessment

- **Positive**

One of the following criteria must be met on 2 or more leads:

- ST Depression $\geq 0.1\text{mV}$
- ST Elevation $\geq 0.2\text{mV}$
- T wave change $\geq 1.0\text{mV}$

- **Borderline**

One of the following criteria must be met on any lead:

- ST Depression $\geq 0.05\text{mV}$
- ST Elevation $\geq 0.1\text{mV}$
- T wave change $\geq 0.5\text{mV}$

- **Negative**

This is assessed if neither the Positive nor Borderline criteria are met.

The following formulas are used to calculate the values in the previous criteria:

- ST depression = (rest ST - post J) - (post exercise ST - post J)
- ST depression = (rest ST - post J) - (post exercise ST - post J)
- T wave change = absolute value of (rest T wave amplitude - post-exercise T wave amplitude)
- (ST - post J: amplitude at the post J point)

When the assessment is positive or borderline, the lead with the largest change prints.



Creating Bar Codes and Magnetic Cards

The following sections provide the information you need to configure bar codes and magnetic patient ID cards.

The bar code reader can read Code 39, 39EX, 128, PDF-417 (2-D), Interleaved Code 2 of 5, and Data Matrix bar codes.

The card reader can read magnetic cards that adhere to ISO 7810 and 7811.

NOTE:

All data resides in fixed-width fields. The bar code or card generator must be programmed to add "trailing spaces" after fields shorter than the fixed length of the fields being used by your system.

Manual Reader Configuration

The following table identifies the available fields for configuring your magnetic card reader and bar code reader. Refer to ["Setting Up a Card Reader" on page 156](#) and ["Setting Up a Bar Code Reader" on page 158](#) for instructions on accessing the configuration window.

When instructed to enter a field's **Offset** and **Length**, keep in mind the following information:

- For **Offset**, enter the field's beginning position.
For the first field in the bar code or magnetic card, the offset will be 0. For the subsequent fields, the offset is typically the sum of the previous field's offset and length. However, this is not always the case; there may be cases where fields may have gaps between them.
- For **Length**, enter the total number of bytes for this field.
Where appropriate, maximum or required lengths are noted, along with any other recommendations or restrictions.

Bar Code Reader and Magnetic Card Reader Configuration Fields

Field	Byte Length
Total number of bytes	Enter the total number of bytes contained in the magnetic patient card or patient bar code. This is typically, but not necessarily, the sum of the bytes listed in the following fields.
Patient ID	The patient's identification number. Enter the field's Offset and Length . Be aware of the following criteria when setting the length: <ul style="list-style-type: none"> • can be from 0 to 16 • should equal the ID length set up on the Patient Question window • should equal the patient ID length for the MUSE CV system with which the MAC system communicates.
Visit	The visit's identification number. Enter the field's Offset and Length . Be aware of the following criteria when setting the length: <ul style="list-style-type: none"> • value can be from 0 to 19 • should equal the visit length from the ADT system
First name	The patient's first name. Enter the field's Offset and Length . Be aware of the following criteria when setting the length: <ul style="list-style-type: none"> • value can be from 0 to 10 • should equal the length from the MUSE CV system with which the MAC system communicates. <p>NOTE: The MAC system does not support "long" names; if the MUSE system uses long names, this field should be set to its maximum value.</p>
Last Name	The patient's last name. Enter the field's Offset and Length . Be aware of the following criteria when setting the length: <ul style="list-style-type: none"> • value can be from 0 to 16. • should equal the length from the MUSE CV system with which the MAC system communicates <p>NOTE: The MAC system does not support "long" names; if the MUSE system uses long names, this field should be set to its maximum value.</p>
Year of birth	The year the patient was born. Enter the field's Offset and Length . The length must be set to 4.
Month of birth	The month the patient was born. Enter the field's Offset and Length . The length must be set to 2.
Day of birth	The day the patient was born. Enter the field's Offset and Length . The length must be set to 2.
Gender	The patient's gender. Enter the field's Offset and Length . The length must be set to 1.

Purchase, Visit

 1-800-654-2055
 Avobus.com

Fields (cont'd.)

	Byte Length
<p>Enable data retrieval</p>	<p>Determines whether the system will issue a query for matching orders or patient information when scanning the bard code or magnetic card. To enable data retrieval, select Yes.</p> <p>The following fields determine what information is used to conduct the query, what information is retrieved, and where the information is retrieved from.</p>
<p>Card Reader Value to Use</p>	<p>Selects the criteria used to query for additional information. Options are:</p> <ul style="list-style-type: none"> • Patient ID This option uses the patient's ID number to retrieve order or ADT information. • Visit This option uses the visit number to retrieve order or ADT information. <p>SWEDEN ONLY: To enable support for Master Patient Index (MPI), you MUST select Patient ID.</p>
<p>Data to Retrieve</p>	<p>Selects the information retrieved. Options are:</p> <ul style="list-style-type: none"> • Orders This option retrieves orders from the MUSE system or cart, depending on the setting of the Retrieve Orders From field. • Orders then ADT if no orders This option first attempts to retrieve matching orders. If no orders are found, it then attempts to retrieve patient demographics. • ADT (Patient Demographics) This option retrieves patient demographics from the associated ADT system. <p>SWEDEN ONLY: To enable support for Master Patient Index (MPI), you MUST select ADT (Patient Demographics).</p>
<p>Retrieve Orders From</p>	<p>Select the source from which to retrieve order information. Options are:</p> <ul style="list-style-type: none"> • MUSE only This option retrieves orders from the associated MUSE CV system. • CART only This option retrieves orders that have already been downloaded to the cart. • Cart then MUSE This option retrieves orders that have already been downloaded to the cart. If it cannot find matching orders on the cart, it attempts to download them from the associated MUSE CV system.

Automatic Reader Configuration

If you are using the automatic configuration feature, use the following information to create a configuration bar code or card.

Automatic Configuration Settings

Field	Character used to reserve byte space
Patient ID	9
First name	5
Last Name	6
Year of birth	3
Month of birth	1
Day of birth	2
Gender	F
Visit Number	8



GE Medical Systems
 Information Technologies, Inc.
 8200 West Tower Avenue
 Milwaukee, WI 53223 USA



GE Medical Systems
 Information Technologies GmbH
 Munzinger Strae 5
 D-79111 Freiburg, Germany

Asia Headquarters

GE Medical Systems
 Information Technologies, Inc.
 Asia; GE (China) Co., Ltd.
 No.1 Huatuo Road
 Zhangjiang Hi-tech Park Pudong
 Shanghai, People's Republic of China 201203
 Tel: +86 21 5257 4650
 Fax: +86 21 5208 2008

To Purchase, Visit

Fax:



1-800-674-2855
 Alobus.com

GE Medical Systems *Information Technologies, Inc.*, a General Electric Company, going to market as GE Healthcare.

www.gehealthcare.com

